

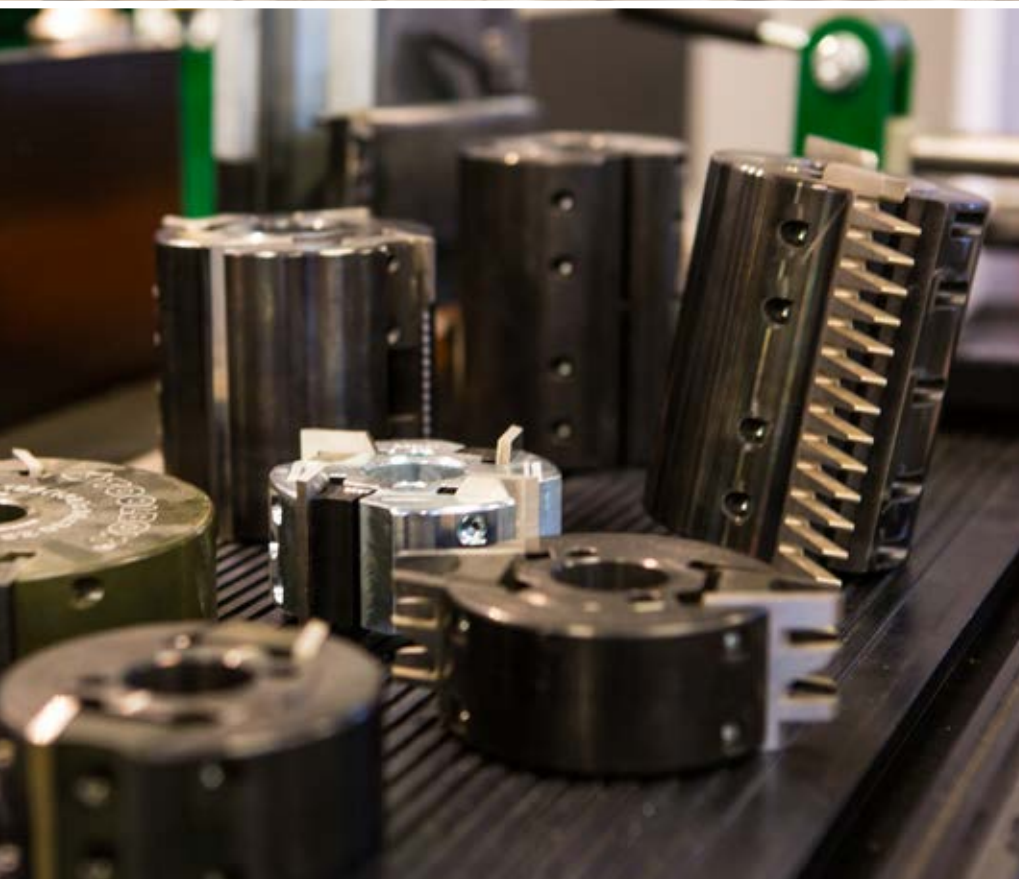

**MACHINE TOOLS FOR
YOUR LOGOSOL MACHINES**



logosol.com



DISCOVER A WIDE PRODUCT RANGE FOR LOGOSOL MACHINES!

Please leaf through our new tool catalogue! Logosol offers a selection of cutting equipment, which includes moulding knives, cutters, blades, end cutters, and other useful cutting tools. Our goal is that you should always be able to choose a Logosol product when you expand your activities.

We offer you an exciting range of tools for hobbyists, craftsmen and light industry in the field of wood processing. You can find the whole range here in our catalogue, in our Internet shop and at our dealers, world-wide. Please contact us, and we will help you find the right product!

We want to be a one-stop supplier for people who work in wood. Logosol has unique experience of small-scale sawing, planing and woodworking. We hope you will find what you need in this catalogue.

You are warmly welcome!

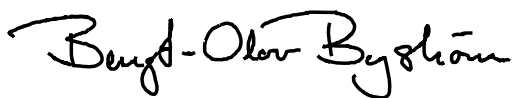

Bengt-Olov Byström

Founder and chairman,
Logosol in Härnösand, Sweden





TABLE OF CONTENTS

TB SYSTEM	4
Tongue and groove	5
Panelling	8
Casing / Baseboards	18
Soffit / crown / cove moulding	26
Joists and Decking	30
Plycaps / Dado mouldings	31
Door profiles	32
Grooving and recessing	33
Round bars	33
Log cabin	34
Corner mouldings	35
Uncategorized mouldings	36
Starter package for Logosols planer/moulders	39
HSS moulding knives 40 x 4 mm	43
HSS moulding knives 50 x 4 mm	48
HSS moulding knives 60 x 4 mm	51
HSS moulding knives 100 x 4 mm	52
HSS moulding knives 130 x 4 mm	53
MAKE YOUR OWN PROFILE	58
UNIVERSAL CUTTER HEADS	60
VERTICAL CUTTER HEADS	70
SKU REGISTER	88
TB System	88
Universal Cutter Heads	90
Vertical Cutter Heads	90

Errors and misprints are reserved.

THIS IS HOW YOU ORDER!

Buying from LOGOSOL is easy. Order from our e-store on www.logosol.com or by phone or email. You are welcome to call us and tell about your projects. We will help you find the right equipment for it.

Welcome to contact us!

LOGOSOL AB
 Fiskaregatan 2
 871 33 Härnösand, SWEDEN
 Phone: +46 611-182 85
 Email: info@logosol.com
 Website: www.logosol.com

TB SYSTEM



The following pages contain a selection of the knives that are available for our TB universal cutters. We have several Swedish and Norwegian standard profiles, and also moulding knives from the American standard collection.

You can choose from 1000 different moulding knives when you set up your own range of planed goods. The knives can be combined in an infinite number of ways, but if you can not find what you are looking for, we can make special knives to your own design.

COMBINATIONS

TONGUE AND GROOVE



Tongue-and-Groove 4 mm (close tolerance, 0.1 mm)

SKU: 94305, 94304



Tongue-and-Groove 4.5 mm (close tolerance, 0.1 mm)

SKU: 94213, 94318



Tongue-and-Groove 6 mm (close tolerance, 0.1 mm)

SKU: 9017, 9016



Tongue-and-Groove 8 mm (t&g floorboards)

SKU: 9017-2, 9016-2



Tongue-and-Groove 10 mm (t&g floorboards)

SKU: 95022, 95021



Tongue-and-Groove 10 mm (close tolerance)

SKU: 9017-3, 9016-3



Tongue-and-Groove (Bath)

SKU: 95039, 95038



Tongue-and-Groove (Bath)

SKU: 95031, 95030



Tongue-and-Groove (Floorboard with nail chamfer)

SKU: 95057, 95056



Tongue-and-Groove (Floorboard)

SKU: 95023, 95024



Tongue-and-Groove (chamfered floorboard profile with nail chamfer)

SKU: 95078, 95079

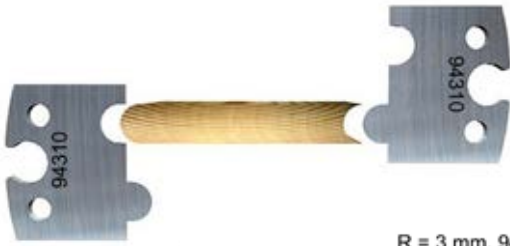

R = 3 mm, 94306.
 R = 4 mm, 94308.
 R = 5 mm, 94310.
 R = 6 mm, 94312.

Tongue-and-Groove (Canoe insert)

SKU: 94306, 94308, 94310, 94312



Tongue-and-Groove (Garden shed)

SKU: 96015, 96014



Tongue-and-Groove (Garden shed USA)

SKU: 95071, 95070



17 mm

SKU: 94675, 94687



20 mm

SKU: 94670, 94671



23 mm

SKU: 94670, 94671



15 mm

SKU: 94675, 94704



21 mm

SKU: 94670, 94684



27 mm

SKU: 94686, 94685



33 mm

SKU: 94686, 94685



15 mm

SKU: 94675, 94687



21 mm

SKU: 94670, 94671

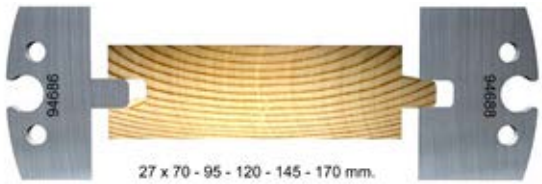

27 mm

SKU: 94686, 94688

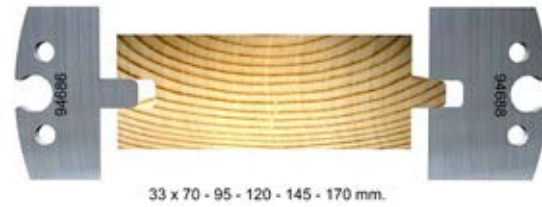

33 mm

SKU: 94686, 94688



Flooring D&M 1" - 1 3/8"

SKU: 95125, 95126



Flooring 1, 1 1/2"

SKU: 95129, 95130



Flooring 2, 1 1/2"

SKU: 95131, 95130



Flooring 1/4" x 1/4"

SKU: 94639, 94638



Flooring

SKU: 94572, 94571, 94573



Flooring

SKU: 94389, 94390



Decking 3/8" x 7/16"

SKU: 95127, 95128



T&G 1/4" x 3/8"

SKU: 94635, 94636



T&G 1 9/16"

SKU: 95133, 95134



T&G 2, 1 9/16"

SKU: 95131, 95135



T&G

SKU: 95086, 95085

COMBINATIONS

PANELLING



Chamfered casing

SKU: 9000-16, 95016, 94214

Can also be used indoors



Chamfered panel, 3 mm tongue

SKU: 94209, 94210



Chamfered panel, 5 mm tongue

SKU: 94207, 94206



Rounded panel

SKU: 94205, 94204



Fillet panel

SKU: 94244, 94260, 94221



Log cabin panel

SKU: 94214, 95012, 95013, 94214



Norwegian panel, swan neck

Vertical tongue-and-groove panel with sawn front.
A 4-insert cutter is needed.

SKU: 94259, 94258



Norwegian panel, moulding

Vertical tongue-and-groove panel with sawn front.
A 4-insert cutter is needed.

SKU: 94214, 94244, 94257, 94258



Log cabin panel, 50 mm

SKU: 95004, 95005



Log cabin panel, 80 mm

SKU: 94200, 94201, 94202, 94203



Fell panel

SKU: 94214, 95012, 95013, 94214



Mora panel

SKU: 94213, 94211, 94212, 94214



Tongued, grooved and beaded timber

SKU: 94213, 95015, 95009, 94214



Tongued, grooved and beaded timber with centre profile

SKU: 94213, 95015, 94345, 95009, 94214



Large tongued, grooved and beaded timber

SKU: 94213, 95015, 95072, 94214



Rounded panel

SKU: 94213, 95017, 94214



Chamfered casing

SKU: 94213, 95015, 94214



45° Chamfered panel

SKU: 94317, 94316



Double 45° Chamfered panel

SKU: 94294, 94293



Chamfered panel with centre profile

SKU: 94213, 95015, 94345, 95017, 94214



Chamfered panel with centre profile

SKU: 94213, 95015, 94359, 95017, 94214



Chamfered casing

SKU: 94277, 94276



Single soffit panel

SKU: 94213, 94384



Top hat casing

SKU: 9000-16, 95011, 94218



Chamfered casing

SKU: 95019, 94218, 95019



Decorative casing

SKU: 95019, 95018, 94218



Decorative casing

SKU: 95020, 94218, 95020



Decorative casing

SKU: 95020, 95018, 94218, 95020



Rustic moulding

SKU: 94700, 94698, 94699



Cover moulding

SKU: 94265, 94698, 94731



Casting moulding

SKU: 94706, 94705



22 x 95 mm

SKU: 94696, 94695



22 x 120-145 mm

SKU: 94694, 94693

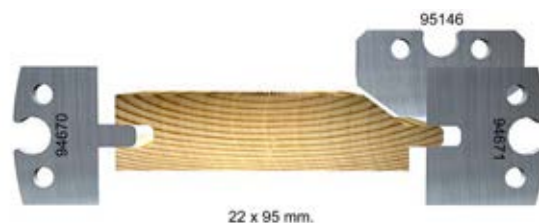

22x95 mm

SKU: 94670, 95146, 94671



22 x 120-145 mm
SKU: 94673, 95146, 94697



22 x 120-145 mm
SKU: 94735, 94734, 9000-16



130 x 22 mm
SKU: 94732, 91344, 94733



12 mm
SKU: 94689, 94691, 94690



15 mm
SKU: 94692, 94691, 94690



Chamfered, indoor, 9 mm
SKU: 94682, 94683



Chamfered, indoor, 12 mm
SKU: 94680, 94681



Chamfered, indoor, 15 mm
SKU: 94680, 94681

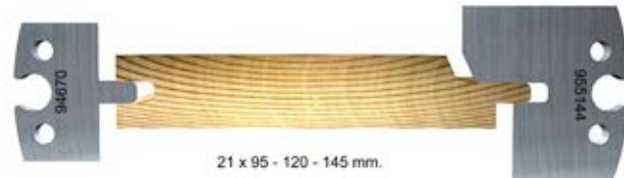

Chamfered, indoor, 21 mm
SKU: 94670, 955144



Straight, indoor, 15 mm
SKU: 94675, 94674



Straight, indoor, 21 mm
SKU: 94670, 955145



Chamfered, outdoor, 22 x 95 mm
SKU: 94677, 94676



Chamfered, outdoor, 22 x 120-145 mm
SKU: 94679, 94678



Straight, 22 mm
SKU: 94673, 94672



Barokkledning

SKU: 95159



Empire batten

SKU: 94744, 94745



Buer casing

SKU: 94737, 94738



Single rabbet

SKU: 94740, 9000-16



Double rabbet 28° chamfer with stagger

SKU: 94740, 94798, 9000-16



Chamfered T&G board

SKU: 94747, 94746



Double rabbet 28° chamfer with stagger

SKU: 94740, 94741, 94739, 9000-16



Tongued, grooved and beaded panel

SKU: 94749, 94748, 94214



Double rabbet 60° chamfer

SKU: 94740, 94738, 9000-16



Rustic T&G board, round edge

SKU: 94751, 95160, 94750



Empire casing

SKU: 9000-16, 94742, 94743



Shadow moulding, round edge

SKU: 94751, 95160, 94750



Sveitser tongued grooved and beaded board

SKU: 94752, 94742, 95161, 94214



Vestland T&G and beaded board with chamfer

SKU: 94740, 94742, 95162, 9000-16



Vestland T&G board with hollow rabbet

SKU: 94751, 95163, 94214



Chamfered casing

SKU: 94654, 94655



Smooth T&G board

SKU: 94656, 94756



Rounded T&G panel with round moulding

SKU: 94658, 95141, 94214



Chamfered T&G panel with round moulding

SKU: 94657, 95140, 94214



Möller cabin panel

SKU: 94661, 94663, 95142, 94214



Tongued, grooved and beaded timber

SKU: 94654, 94664, 94214



Rustic T&G casing, round edge

SKU: 94658, 95143, 94214



Rustic panel, chamfered edge

SKU: 94657, 94665, 94214



Shadow panel, square edge

SKU: 94661, 94668



Shadow panel, chamfered edge

SKU: 94657, 94665, 94214



Lower panel

SKU: 94667, 94666



Double groove panel, joining piece

SKU: 94244, 94214



Joining panel, square edge

SKU: 94661, 94662



Joining panel, round edge

SKU: 94658, 94659



Joining panel, chamfered edge

SKU: 94657, 94660



TB133

SKU: 94474, 94472, 94473



TB134

SKU: 94471, 94469, 94470



TB135

SKU: 94468



Batten big

SKU: 94414, 94415, 94413



Ogee batten, small

3/4" x 1-3/4"

SKU: 94417, 94418, 94416



TB224

9/16" x 2 1/4"

SKU: 94583, 94584



TB229

1 1/16" - 1-5/8"

SKU: 94575, 94576



TBBT9

SKU: 94559, 94560



TBBT7

SKU: 96062



Ceiling 1 x 6 EV

23/32" x 5-3/8"

SKU: 94443, 94444



Ceiling 5-8 x 4 EB

9/16" x 3-3/8"

SKU: 94449, 94448, 94450



Ceiling 5-8 x 4 V

9/16" x 3-3/8"

SKU: 94451, 94452



3/4" X 3 3/8" - 10 7/8"

T&G 1/4" x 1/4"

SKU: 94637, 94638



3/4" X 3 1/2" - 10 3/4"

Shiplap 1/2"

SKU: 94647



23/32" x 5-3/8"

Ceiling E-CB

SKU: 94446, 94447, 94448, 94411



1 9/16" X 4 - 11", 1/2" LAP

Shiplap 2" - 12"

SKU: 95122



23/32" x 5-3/8"

Ceiling CV

SKU: 94443, 94445, 94444



11/16" X 1-5/8"

TB182

SKU: 94619, 94618, 94620



9/16" x 3-3/8"

E-CV Ceiling

SKU: 94454, 94453, 94455



9/16" X 1-1/8"

TB183

SKU: 94617, 94616



9/32" X 1-3/8"

TB185

SKU: 94621



Ambers

SKU: 94546, 94545



Siding 101

SKU: 94430, 95088, 9400-20



23/32" X 5 3/8" - 11 1/8"

Channel rustic siding

SKU: 95132, 94647



Siding 104

SKU: 94433, 94434, 95089, 94411



3/4" X 3 1/2" - 10 7/8"

Shiplap, 3/8" lap

SKU: 94648, 94648



Siding 105

SKU: 94430, 95090, 9400-20



Siding 106
SKU: 94410, 95091, 94411



Siding 115
SKU: 94437, 91087, 91088, 9000-20



Siding 118
SKU: 94439, 96027, 91089, 94411



Siding 124
SKU: 94410, 91343, 94411



Siding 102
SKU: 94410, 95089, 94411



Siding 103
SKU: 94431, 94432, 95088, 9000-16



Siding 109
SKU: 94430, 95092, 9000-16



Siding 115
SKU: 9000-16, 91075, 91076, 94437



Siding 117
SKU: 9000-16, 91074, 96075, 94644



Siding 118
SKU: 94439, 96027, 91073, 94411



V-CV Rustic
SKU: 94440, 94442, 94441



WP 2-WP 4
SKU: 94400, 94419, 96025, 94369



WP 3
SKU: 94402, 94403, 94401



WP 4
SKU: 94420, 94421



WP 6 SKU: 94405, 94425, 94425, 94396



WP 7 SKU: 94422, 94424, 94423



WP 8 SKU: 94400, 94404, 94369



WP 9 SKU: 94426, 94407, 9000-20



WP 10 SKU: 94405, 94406, 94396



WP 11 SKU: 94422, 94423



WP 12 SKU: 94397, 94399, 94396



WP 13 SKU: 94401, 94407, 91072



WP 14 SKU: 94397, 94398, 94396



WP 16 SKU: 94420, 94424, 94421



WP 18 SKU: 94420, 94424, 94421



1 x 4 E-CV Partition SKU: 94458, 94453, 94459



1 x 6 E-CV Partition SKU: 94456, 94445, 94457

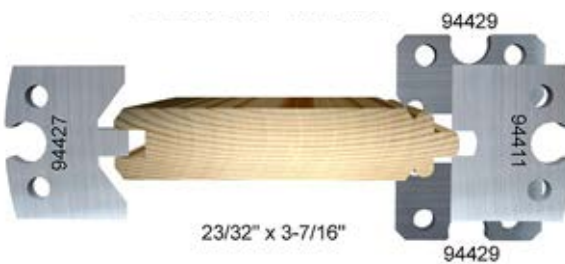

Beaded partition SKU: 94427, 94429, 94411, 94429



E-CB Partition

SKU: 94458, 94447, 94448, 94411

23/32" x 5-3/8"



E-CV Partition

SKU: 94460, 94453, 94461

9/16" x 3-3/8"



V Partition

SKU: 94458, 94459

23/32" x 3-7/16"

COMBINATIONS

CASING / BASEBOARDS



Fillet

SKU: 95025, 94269



Log cabin moulding

SKU: 95025, 95013



Swan neck moulding

SKU: 95025, 94259



Quarter-round moulding

SKU: 94272



Rustic moulding

SKU: 95025, 94215, 90129



Haga moulding

SKU: 95025, 95033



Gamlestad moulding

SKU: 95025, 95017, 94259



Stockholm moulding

SKU: 95025, 96009, 94267



Gotland moulding

SKU: 95025, 91081, 94265



Halland moulding

SKU: 95025, 91002



Backa moulding

SKU: 95025, 94357



Utby moulding

SKU: 95025, 96018, 94353



Villa Frimodig

SKU: 95025, 91321



Log cabin casing

SKU: 94248, 95013



Rustic casing

SKU: 94248, 94215, 90129



American casing, 57 mm

SKU: 9000-16, 96019, 94208



Backa casing

SKU: 94356, 94357



Decorative casing, 70 mm

SKU: 94251, 96003



Decorative casing, 95 mm

SKU: 94251, 91001



Quarter-round casing

SKU: 94272



Gamlestad casing

SKU: 94248, 95017, 94259



Door trim

SKU: 94208, 91025



Rounded casing

SKU: 94268, 94285



Gotland casing

SKU: 94258, 91080, 94257



Skirö casing

SKU: 94356, 96022, 94383



Haga casing

SKU: 94248, 95033



Stockholm casing

SKU: 94248, 96009, 94267



Halland casing

SKU: 94248, 91002



Swan neck casing

SKU: 94248, 94259



Sätra casing

SKU: 91083, 94354



Utby casing

SKU: 94356, 96018, 94353



Villa Frimodig

SKU: 94329, 91020



43 mm

9,5 / 12 x 43 mm.

SKU: 94208, 94702



56 mm

9,5 - 12 - 15 x 56 mm.

SKU: 94208, 96072



69 mm

12 x 69 mm.

SKU: 94208, 91079



43 x 12 mm

43 x 21 mm.

SKU: 94208, 95158, 94248



56 x 21 mm

56 x 21 mm.

SKU: 94208, 96071, 94248



43 mm

9,5 / 12 x 43 mm.

SKU: 94208, 94736, 94701



56 mm

9,5 / 12 x 56 mm.

SKU: 94208, 95148, 94701



69 mm

12 x 69 mm.

SKU: 94208, 91078, 94701



43 x 21 mm.

43 x 21 mm

SKU: 94208, 95158, 94248

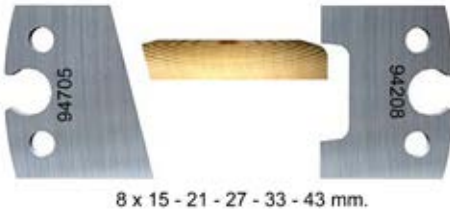

8 x 15 - 21 - 27 - 33 - 43 mm.

8 x 15 - 21 - 27 - 33 - 43 mm

SKU: 94705, 94208



TBBA1

SKU: 94554, 94555



TBBA19

SKU: 94553



TBBA21

SKU: 94556



TBBA68

SKU: 94551



TBBA70

SKU: 94557, 94558



TBBA42

SKU: 94552



Fortune

SKU: 94465, 91064



TB442

SKU: 95139, 94494



TB307

SKU: 96029, 94479



TB315

SKU: 96030, 94480



TB316

SKU: 96031, 94481



TB321

SKU: 95094, 94482



TB324

SKU: 96032



TB327
SKU: 96033, 94483



TB328
SKU: 95095, 94484



TB329
SKU: 95096, 94485



TB330
SKU: 95097, 94486



TB332
SKU: 94487, 94488



TB346
SKU: 95098



TB351
SKU: 94208, 96035



TB356
SKU: 94208, 96034



TB361
SKU: 94464, 95099, 94489



TB366
SKU: 94490, 94491



TB387
SKU: 94208, 95100



TB413
SKU: 94467



TB440
SKU: 94208, 96036, 94492



TB444
SKU: 94463, 91029, 94466



TB501
SKU: 94463, 96037



TB502
SKU: 94463, 96038



TB503
SKU: 94208, 96039



TB504
SKU: 94463, 96040



TB506
SKU: 94463, 91030



TB507
SKU: 94463, 96042, 94496



TB508
SKU: 94463, 96041, 94495



TB509
SKU: 94466, 95102, 94498



TB510
SKU: 94465, 95101, 94497



TB511 SKU: 96043, 94501



TB512 SKU: 91031



TB515 SKU: 91032



TB2000 SKU: 94503, 91327, 94502



TB2001 SKU: 94505, 96046, 94505



TB2002 SKU: 91033



TB2003 SKU: 91035



TB2004 SKU: 91034



TB2005 SKU: 94507, 94506, 94508



TB2006 SKU: 91036



TB2007 SKU: 91037



TB2008 SKU: 91038



TB2009 SKU: 91039



TB2010 SKU: 96047



TB2011 SKU: 94463, 96048, 94463



TB2012 SKU: 94465, 91040, 94509



TB2013 SKU: 94463, 91041, 94463



TB2014 SKU: 96049



TB2015 SKU: 91042



TB2033 SKU: 94510, 96050, 94511



TB2039 SKU: 94513, 94512, 94514



TB2045 SKU: 94464, 95103, 94464



TB2051 SKU: 95104



TB2057 SKU: 94516, 94515, 94517



TB2063 SKU: 91043



TBA44 SKU: 91328



TBMK0047 SKU: 91047



TB2069 SKU: 94248, 95105, 94518



TBCA33 SKU: 95114, 94561



TBCA294 SKU: 94565, 91063, 94566



TB2075 SKU: 94465, 95106, 94519



TBCA52 SKU: 91080



TBA45 SKU: 94528, 91046, 94529



TB2081 SKU: 94463, 95107, 94463



TBCA147 SKU: 91059



TB2087 SKU: 94520, 91044



TBCA180 SKU: 94562, 91061, 94563



TBCA197 SKU: 96063



TBA41 SKU: 94524, 96053, 94523



TBCA261 SKU: 94567, 94568



TBA42 SKU: 94526, 94525, 94527



TBCA263 SKU: 91062



TBA43 SKU: 94526, 91045, 94527

COMBINATIONS

SOFFIT / CROWN / COVE MOULDING



Shadow moulding

SKU: 94262, 95036, 94263



Staircase moulding

SKU: 94274, 94273, 95019



Quarter-round soffit moulding

SKU: 94216, 94249



Profile soffit moulding, 70 mm

SKU: 95032, 96006



Swan neck soffit moulding, 45 mm

SKU: 94216, 94215



Swan neck soffit moulding, 56 mm

SKU: 94216, 95014



Swan neck soffit moulding, 68 mm

SKU: 94216, 96007



Swan neck soffit moulding, 80 mm

SKU: 95032, 91082



Swan neck soffit moulding, 95 mm

SKU: 95032, 91023



Swan neck soffit moulding, 120 mm

SKU: 95032, 91301



Swan neck soffit moulding, USA, 80 mm

SKU: 95073, 91082



Hollow soffit moulding, 45 mm

SKU: 94216, 94215,



Utby soffit moulding

SKU: 94355, 95016, 94353



Hollow soffit moulding, 60 mm

SKU: 95010



Villa Frimodig

SKU: 95032, 91320



Hollow soffit moulding, 70 mm

SKU: 96005

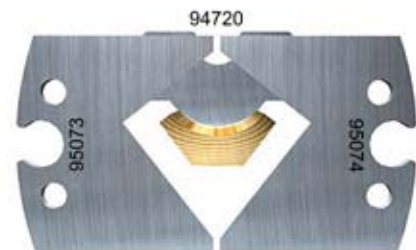

27 mm

27 x 12 mm.

SKU: 95073, 94720, 95074



Hollow soffit moulding, 95 mm

SKU: 91003



43 mm

15 x 43 mm.

SKU: 94216, 94721



Plaster cornice moulding

SKU: 94264, 94266, 94265



Backa soffit moulding

SKU: 95032, 91022



69 mm

SKU: 96069





TB52 SKU: 96055



TB53 SKU: 96056



TB54 SKU: 95109



TB57 SKU: 91051



TB58 SKU: 95110



TB59 SKU: 94542



TB60 SKU: 94543



TB67 SKU: 95111



TB68 SKU: 94544



TB4020 SKU: 91330



TB4025 SKU: 91331



TB4026 SKU: 91332



TB4027 SKU: 91052



TB4028 SKU: 91053



TB4029 SKU: 91054



TB4030 SKU: 96057



TB4034 SKU: 91055



TB4037 SKU: 91333



TB4039 SKU: 91056



TB4045 SKU: 91057



TBMK0044 SKU: 95112



TBMK0045 SKU: 96058



TBMK4061 SKU: 91058



TBMK0046 SKU: 94574, 96089, 95073

COMBINATIONS

JOISTS AND DECKING



Straight SKU: 9500-16



Rounding, single SKU: 95006, 95007



Rounding, double, 19 mm SKU: 94208



Rounding, double, 25 mm SKU: 94295



Rounding, double, 28 mm SKU: 94248



Rounding, double, 48 mm SKU: 96017



Grip profile 1 SKU: 96020



Grip profile 2 SKU: 91004



Grip profile 3 SKU: 96021



22 mm 22 x 70 - 95 mm. SKU: 94208



28 mm 28 x 95 mm. SKU: 94248



34 mm 34 x 95 mm. SKU: 95147



Joist 45 mm SKU: 95008



1/8" Radius X 3/4" Thick

TBEE001

SKU: 94585



3/16" Radius x 3/4" Thick

TBEE002

SKU: 94586



1/8" Radius x 1" Thick

TBEE003

SKU: 94587



3/16" Radius X 1" Thick

TBEE004

SKU: 94588



1/8" Radius X 1-1/2" Thick

TBEE005

SKU: 95121



1/8" Radius X 1-1/2" Thick

TBEE006

SKU: 95122



SKU: 94275



SKU: 95047

COMBINATIONS

PLYCAPS / DADO MOULDINGS



Rounded

SKU: 94244, 96002



Profile

SKU: 94244, 96004



Profile

SKU: 95075, 94214



Villa Fridodig

SKU: 94330, 91021



TB290

SKU: 94623, 94622

11/16" X 1-3/8"



TB292

SKU: 94624, 94622

9/16" X 1-1/8"



11/16" X 1-1/8"

TB294

SKU: 94625, 94622



1/2" X 1-1/4"

TB295

SKU: 94626, 94622



3/4" X 3/4"

TB296

SKU: 94627, 94646

COMBINATIONS

DOOR PROFILE



SKU: 94760



SKU: 94759



SKU: 94758

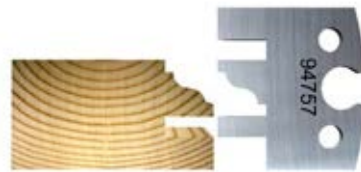

SKU: 94757



Door profile 1

SKU: 95082



Door profile 1

SKU: 95083



Door profile 2

SKU: 95002



Door profile 2-2

SKU: 95003

COMBINATIONS

GROOVING AND RECESSING



Grooving of casings

SKU: 94219



Cutouts in casings

SKU: 94261



Cutouts in base board

SKU: 96008

COMBINATIONS

ROUND BARS

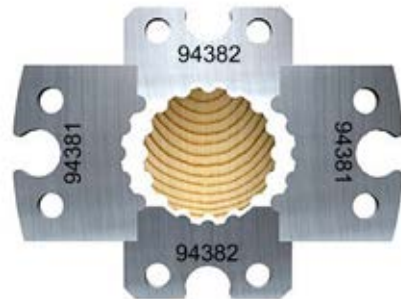

Diameter 33 mm

(also suitable for making dowels for log cabins)

SKU: 94381, 94382



Round bar, 24 mm

SKU: 94302, 94301, 94303



Round bar, 40 mm

SKU: 95045, 94253, 95046



Radius 12 mm.

12 mm

SKU: 94707, 94708, 94709



15 mm

Radius 15 mm.

SKU: 94713, 94714, 94715



21 mm

Radius 21 mm.

SKU: 94710, 94711, 94712



27 mm

Radius 27 mm.

SKU: 94716, 94717, 94718



33 mm

Radius 33 mm.

SKU: 95153, 94719, 95154



43 mm

Thickness 5.5 mm

SKU: 956067, 95155, 956068

COMBINATIONS

LOG CABIN



TB3400

3/4" X 3-1/2"

SKU: 94615, 91070, 94614



TB3405

3/4" X 4"

SKU: 94615, 91071, 94614



TB3405

3/4" X 4-1/2"

SKU: 94615, 91340, 94614

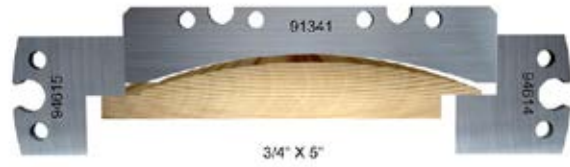

TM3420

3/4" X 5"

SKU: 94615, 91341, 94614



TB3430

3/4" X 5-1/2"

SKU: 94615, 91342, 94614

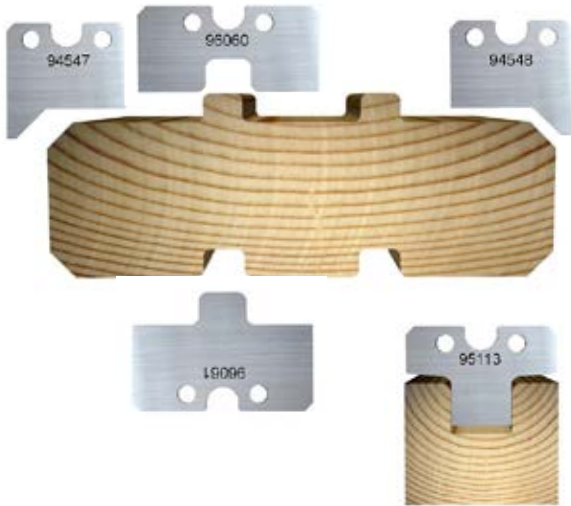

Logg 4" - 8" Chamfer

SKU: 94547, 96060, 94548, 96061, 95113

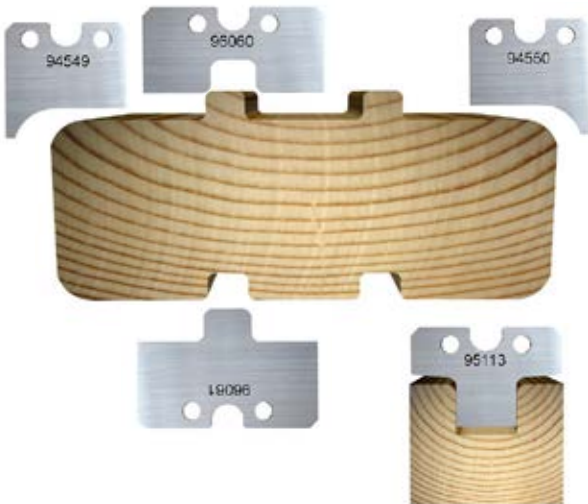

Logg 4" - 8" Rounded

SKU: 94549, 96060, 94550, 96061, 95113

COMBINATIONS

CORNER MOULDINGS

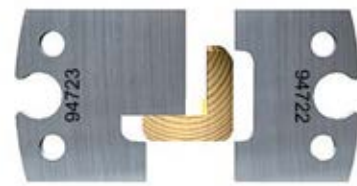

21 x 21 mm.

21 mm

SKU: 94723, 94722



27 x 27 mm.

27 mm

SKU: 94725, 94724



33 x 33 mm.

33 mm

Thickness 5.5 mm

SKU: 955157, 95156



43 x 43 mm.

43 mm

SKU: 96070, 9000-16

COMBINATIONS

UNCATEGORIZED MOULDINGS



Double 45° chamfer

SKU: 95032



Single 45° chamfer

SKU: 94380



Lower window lining, profiled lower board

SKU: 95076



Lower window lining

SKU: 95027, 94358



Lower window lining, Villa Frimodig

SKU: 95058, 95059



Lower window lining

SKU: 94332, 94331

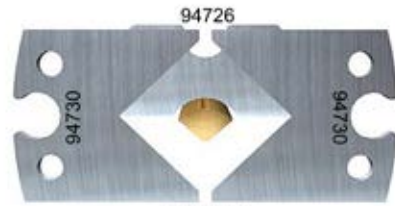

9 x 9 mm.

Quarter-round moulding, 9 mm

SKU: 94730, 94726



12 x 12 mm.

Quarter-round moulding, 12 mm

SKU: 94730, 94727



15 x 15 mm.

Quarter-round moulding, 15 mm

SKU: 94730, 94728



21 x 21 mm.

Quarter-round moulding, 21 mm

SKU: 94730, 94729



Triangular moulding, 15/21 mm

SKU: 94730



21 x 33 mm.

Shadow moulding, 21x33 mm

SKU: 95149, 94703



33 x 43 mm.
Shadow moulding, 33x43 mm
 SKU: 95149, 956073



21 x 43 mm.
Shadow moulding, 21x43 mm
 SKU: 95151, 95152



Beads, shelving 2 bead
 SKU: 94409



Beads, shelving 3 bead
 SKU: 94408



Bullnose, TB5004
 SKU: 94580



Bullnose, TB5005
 SKU: 94581



Bullnose, TB5006
 SKU: 95120



Bullnose, TB5007
 SKU: 94582



Chair rails, TB303
 SKU: 94531, 95108, 94530



Chair rails, TB304
 SKU: 94467, 96054,



Chair rails, Shiplap EV15
 SKU: 95124, 95123



Doorstop, TB816
 SKU: 94643



Doorstop, TB827
 SKU: 94589



Doorstop, TB848
 SKU: 94590

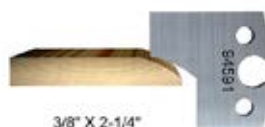

Doorstop, TB853
 SKU: 94591



Doorstop, TB877
 SKU: 94592



Doorstop, TB886
 SKU: 94593



Doorstop, TB908
 SKU: 94594

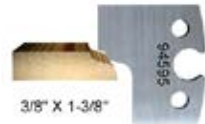

Doorstop, TB916
 SKU: 94595



Doorstop, TB947
 SKU: 94596



Glass bead, TB147
 SKU: 94597



Glass bead, TB148
 SKU: 94598



Glass bead, TBMK002
 SKU: 94768



1/2" X 15/16"

Glass bead, TBMK003

SKU: 94600



11/16" X 3/4"

Glass bead, TBMK004

SKU: 94601



3/8" X 3/8"

Glass bead, TBMK005

SKU: 94602



5/8" X 3/8"

Glass bead, TBMK006

SKU: 94603



1/2" X 13/16"

Glass bead, TBMK007

SKU: 94604



3/8" X 11/16"

Glass bead, TBMK008

SKU: 94605



1/2" X 1/2"

Glass bead, TBMK009

SKU: 94606



5/8" X 3/8"

Glass bead, TBMK0010

SKU: 94607



3/8" X 3/4"

Glass bead, TBMK0011

SKU: 94608



1/2" X 5/8"

Glass bead, TBMK0012

SKU: 94609



1/2" X 11/16"

Glass bead, TBMK0013

SKU: 94610



9/16" X 1/2"

Glass bead, TBMK0014

SKU: 94611



1/2" X 3/4"

Glass bead, TBMK0015

SKU: 94612



3/8" X 5/8"

Glass bead, TBMK0016

SKU: 94613



1" X 1"

Quater round, TB104

SKU: 95032, 94628



3/4" X 3/4"

Quater round, TB105

SKU: 94629



11/16" X 11/16"

Quater round, TB106

SKU: 94630



5/8" X 5/8"

Quater round, TB107

SKU: 94631



1/2" X 1/2"

Quater round, TB108

SKU: 94632



3/8" X 3/8"

Quater round, TB109

SKU: 94633



1/4" X 1/4"

Quater round, TB110

SKU: 94634

STARTER PACKAGE WITH MOULDING KNIVES AND GIBS

FOR THE PLANER/MOULDER PH260

The package includes:

14 pairs of moulding knives of HSS and 3 pairs of gibs. The starter package of moulding knives allows you to produce a wide range of profiles. See for example the set-ups to the right. Let these examples of wood profiles inspire you, but you can make much more with the starter package!



Starter package with moulding knives and gibs for the PH260

LOGOSOL PH260 four-sided planer/moulder

SKU: TB90-009

Examples of wood profiles you can make with the knives in the starter package:



SKIRTING BOARDS

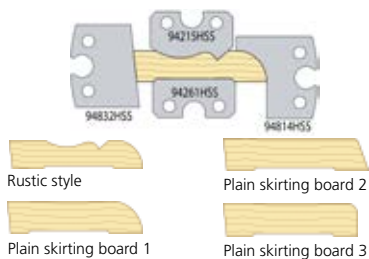

PANELLING

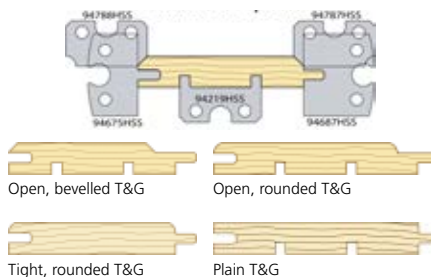

CORNICES

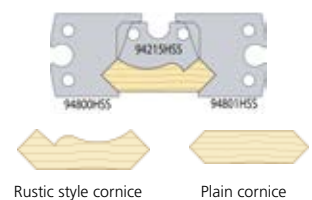

CASINGS

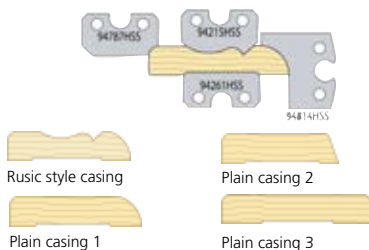

WAINSCOT MOULDINGS

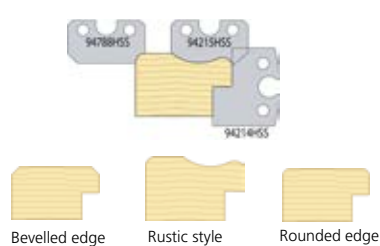

JOISTS & DECKING

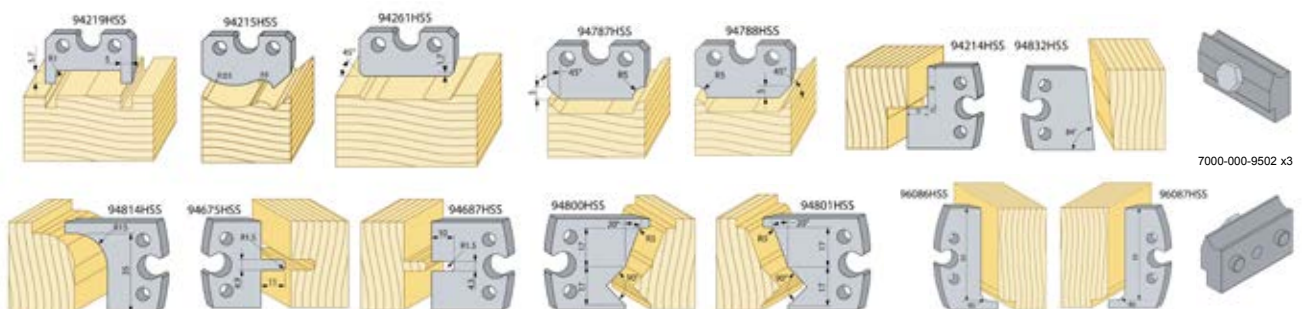
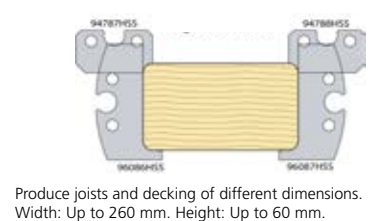

SKU TB90-009 contains of:

94219, 94215, 94261, 94787, 94788, 94214, 94832, 7000-000-9502, 94814, 94675, 94687, 94800, 94801, 96086, 96087

STARTER PACKAGE WITH MOULDING KNIVES AND GIBS

FOR THE PLANER/MOULDER PH360/PH365

The package includes:

14 pairs of moulding knives of HSS and 3 pairs of gibs. The starter package of moulding knives allows you to produce a wide range of profiles. See for example the set-ups on the previous page. Let these examples of wood profiles inspire you, but you can make much more with the starter package!

Starter package with moulding knives and gibs for the PH360/PH365

SKU: TB90-008



LOGOSOL PH360 four-sided planer/moulder



You can do all this and much more with the starter package!

Our planer/moulders are perfect for custom-made knives. A common request is wide floorboards for old houses.

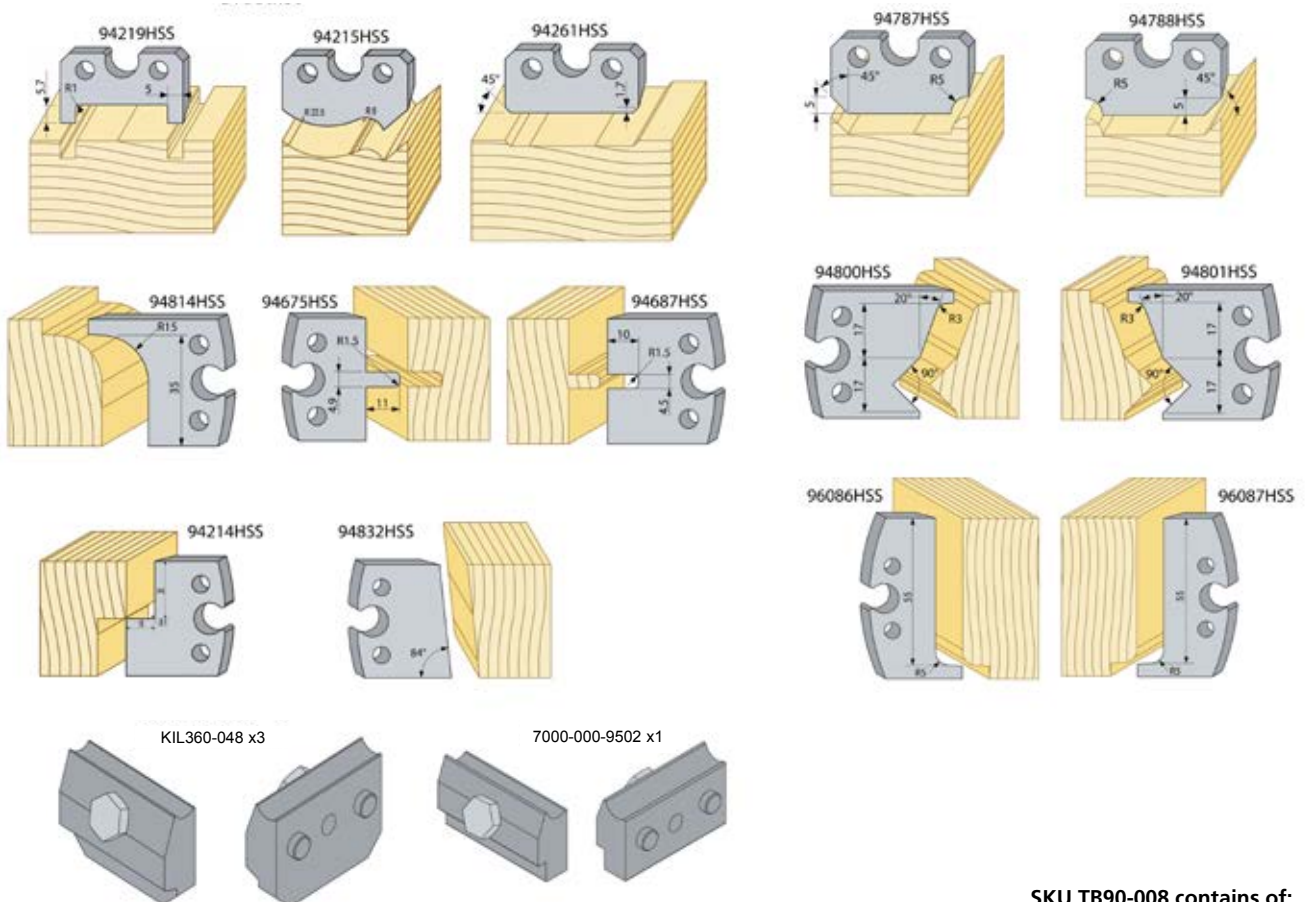

SKU TB90-008 contains of:

94219, 94215, 94261, 94787, 94788, 94814, 94675, 94687, 94800, 94801, 94214, 94832, 96086, 96087, KIL360-084, 7000-000-9502

STARTER PACKAGE WITH MOULDING KNIVES AND GIBS

FOR THE PLANER/MOULDER DH410

The package includes:

10 pairs of moulding knives of HSS, and 2 pairs of knife gibs.

The starter package of moulding knives allows you to produce a wide range of profiles. Our experience tells us that these profiles will without doubt be very useful to you.



Starter package with moulding knives and gibs for the DH410

SKU: TB90-011

LOGOSOL DH410 two-sided planer/moulder

Examples of wood profiles you can make with the knives in the starter package:



SKIRTING BOARDS

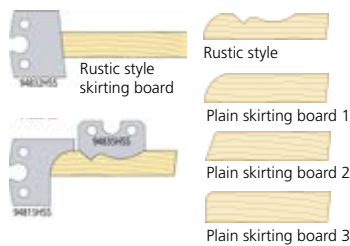

CORNICES

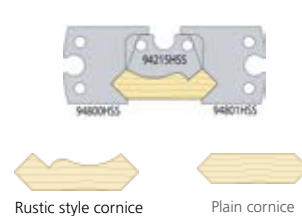

PANELLING

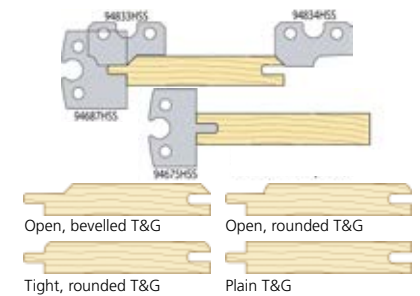

CASINGS

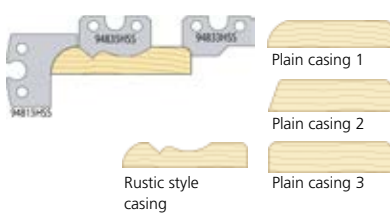

WAINSCOT MOULDINGS

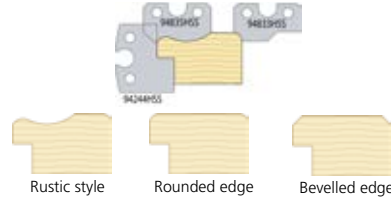

JOISTS AND DECKING

Produce joists and decking of different dimensions.
Width: Up to 410 mm.
Height: Up to 60 mm.

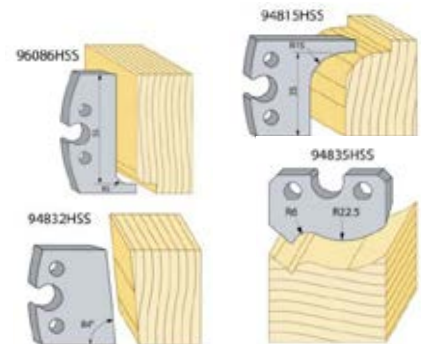
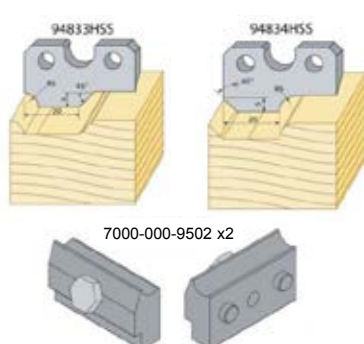
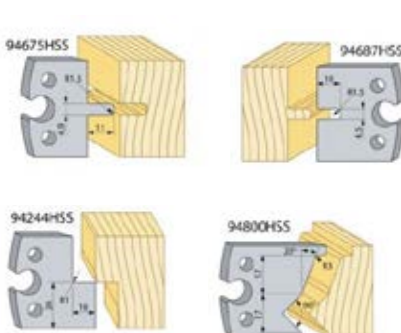
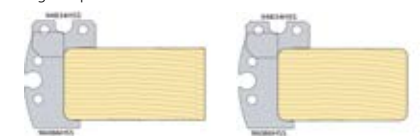

SKU TB90-011 contains of:

94675, 94687, 94833, 94834, 96086, 94815, 94244, 94800, 7000-000-9502, 94832, 94835

STARTER PACKAGE WITH MOULDING KNIVES AND GIBS

FOR THE SOLO PLANER SH410

The package includes:

9 pairs of moulding knives of HSS, 3 pairs of gibs and one pair of position holders. Look at the examples of knife combinations to the right. Let these examples inspire you, but you can make much more with the starter package!



SKU: TB90-010



LOGOSOL SH410 solo planer

Examples of wood profiles you can make with the knives in the starter package:

SKIRTING BOARDS

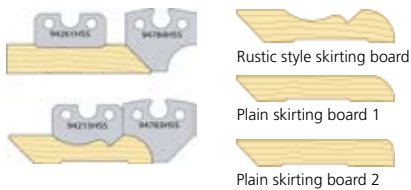

CORNICES

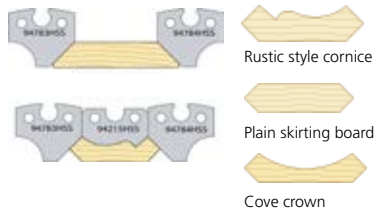

CASINGS

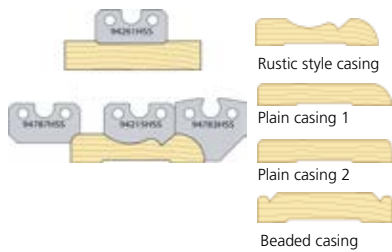

WAINSCOT MOULDINGS

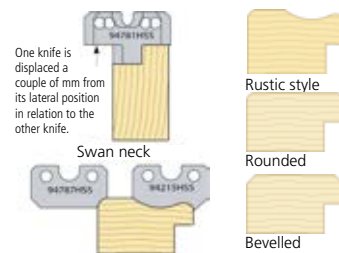

JOISTS & DECKING

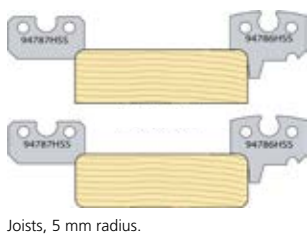

PANELLING

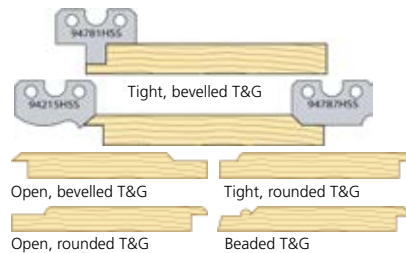

KNIVES FOR T&G PRODUCTION WITH THE SH410

The package includes:

Three selected knife pairs for tongue and groove. Hot tub knives, garden cabin knives and T&G knives. They fit in the top cutter of the SH410. You have to machine the workpiece twice for a finished profile.

SKU: 7504-555-9999

HOT TUB KNIVES, 50 MM

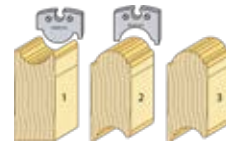

GARDEN CABIN KNIVES, 50 MM



T&G KNIVES, 40 MM

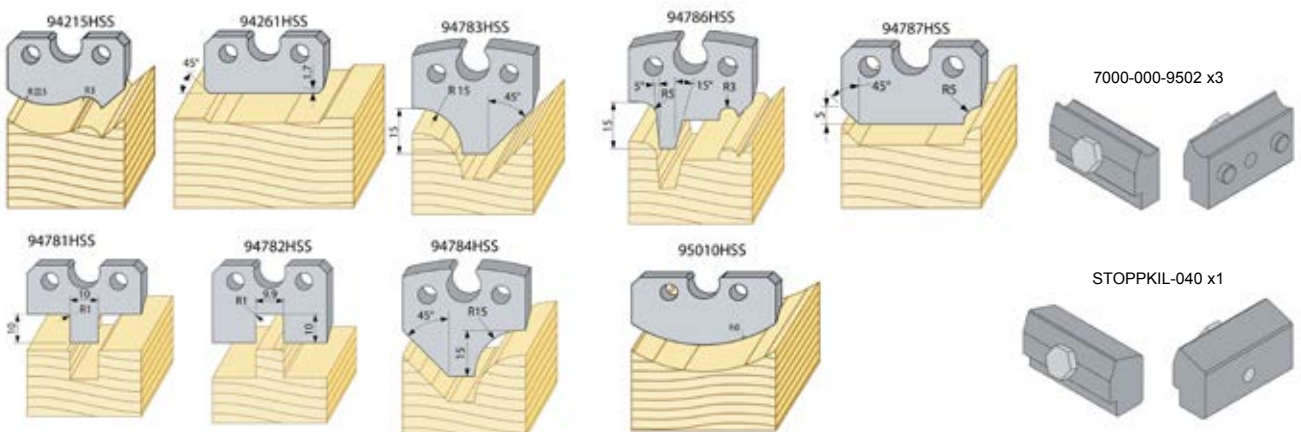
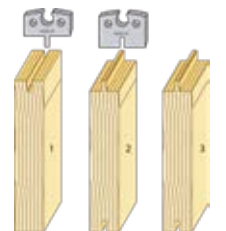

SKU TB90-010 contains of:

94215, 94261, 94783, 94786, 94787, 7000-000-9502, 94781, 94782, 94784, 95010, STOPPKIL-040

40 MM

HSS MOULDING KNIVES 40X4MM

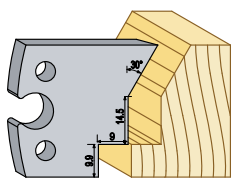

SKU: 94200

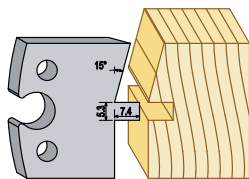

SKU: 94207

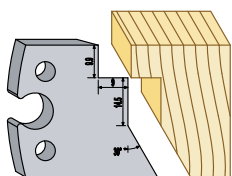

SKU: 94201

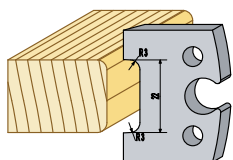

SKU: 94208

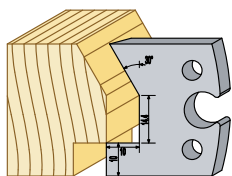

SKU: 94202

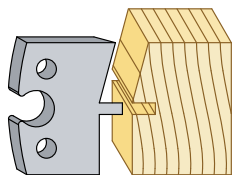

SKU: 94209

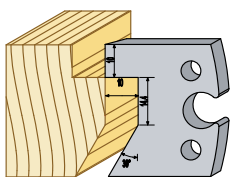

SKU: 94203

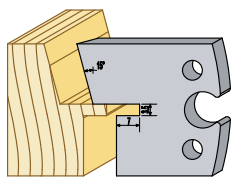

SKU: 94210

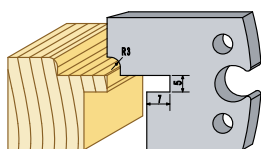

SKU: 94204

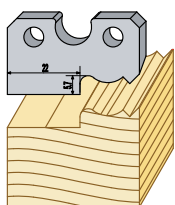

SKU: 94211

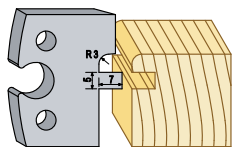

SKU: 94205

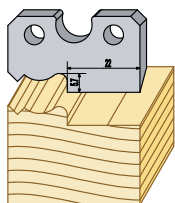

SKU: 94212

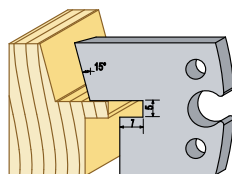

SKU: 94206

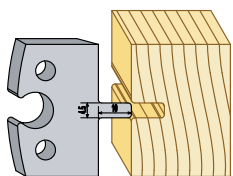

SKU: 94213

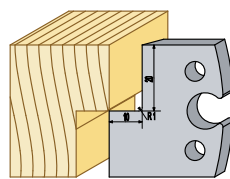

SKU: 94214

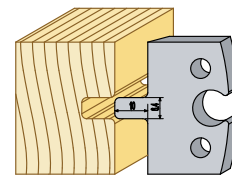

SKU: 94221

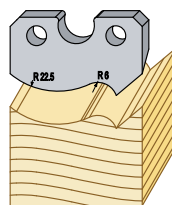

SKU: 94215

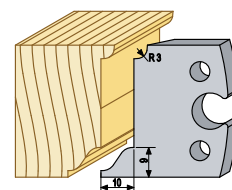

SKU: 94222

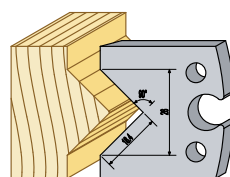

SKU: 94216

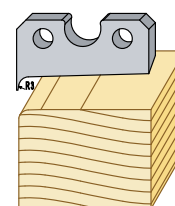

SKU: 94223

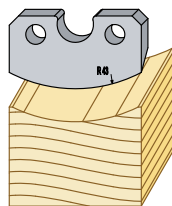

SKU: 94217

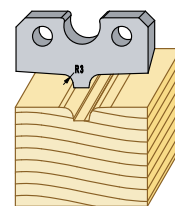

SKU: 94224

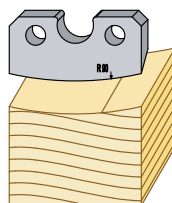

SKU: 94218

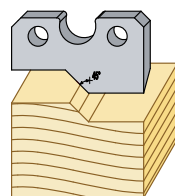

SKU: 94225

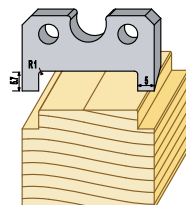

SKU: 94219

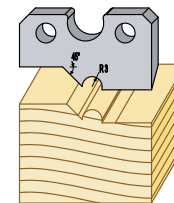

SKU: 94226

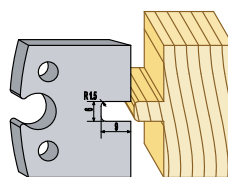

SKU: 94220

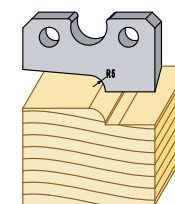

SKU: 94227

HSS MOULDING KNIVES 40X4MM

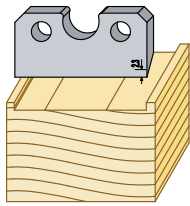

SKU: 94229

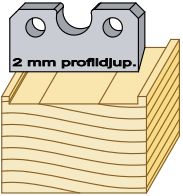

SKU: 94232

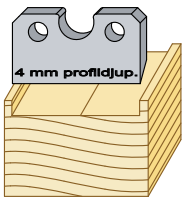

SKU: 94234

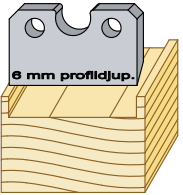

SKU: 94236

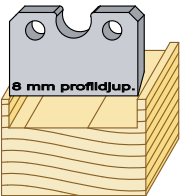

SKU: 94238

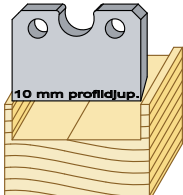

SKU: 94240

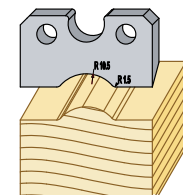

SKU: 94241

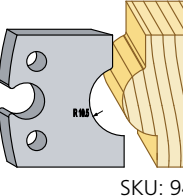

SKU: 94242

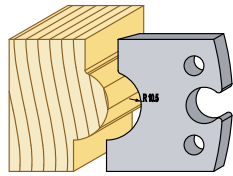

SKU: 94243

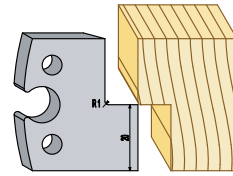

SKU: 94244

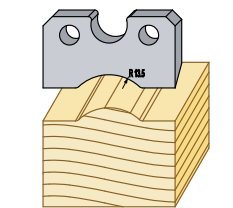

SKU: 94245

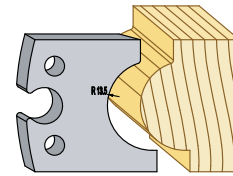

SKU: 94246

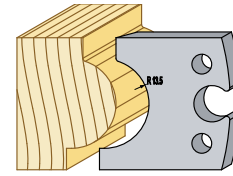

SKU: 94247

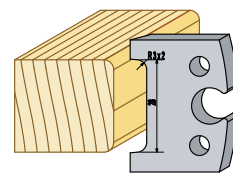

SKU: 94248

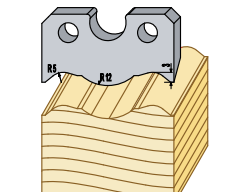

SKU: 94249

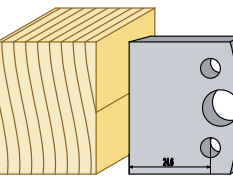

SKU: 94250

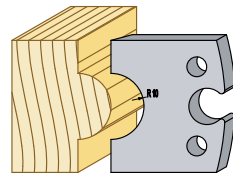

SKU: 94251

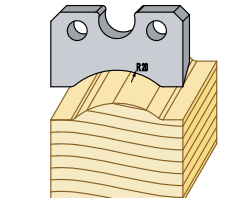

SKU: 94253

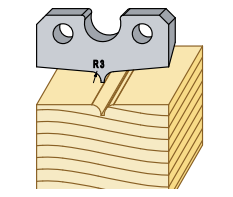

SKU: 94254

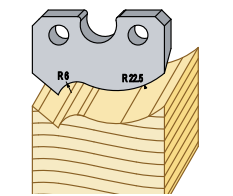

SKU: 94255

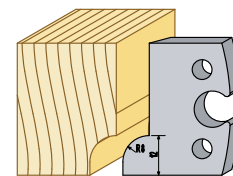

SKU: 94256

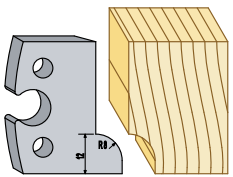

SKU: 94257

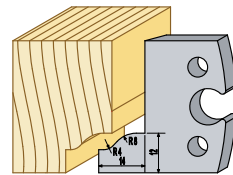

SKU: 94258

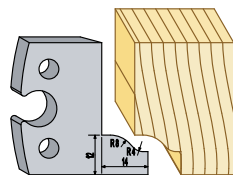

SKU: 94259

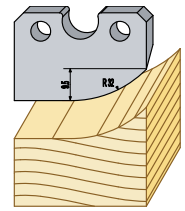

SKU: 94260

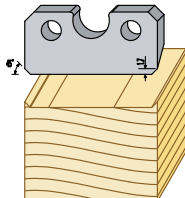

SKU: 94261

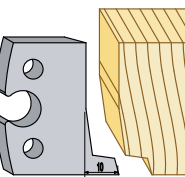

SKU: 94262

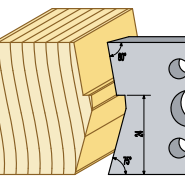

SKU: 94263

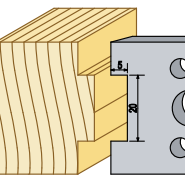

SKU: 94264

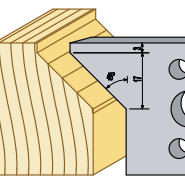

SKU: 94265

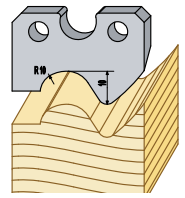

SKU: 94266

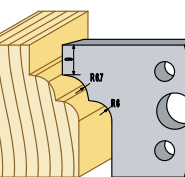

SKU: 94267

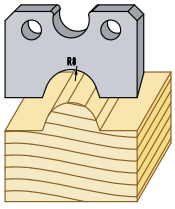

SKU: 94268

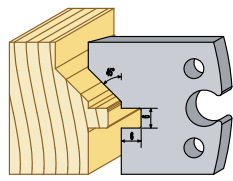

SKU: 94276

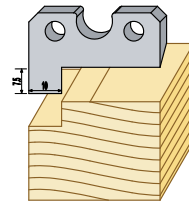

SKU: 94284

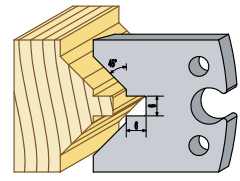

SKU: 94293

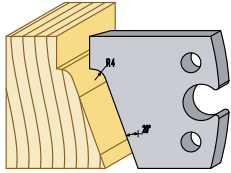

SKU: 94269

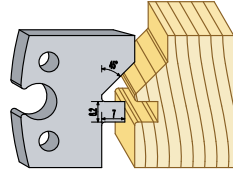

SKU: 94277

Only Solo plane

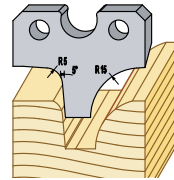

SKU: 94285

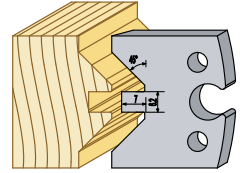

SKU: 94294

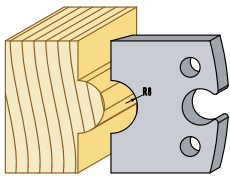

SKU: 94270

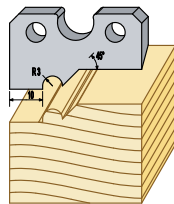

SKU: 94278

Only Solo plane

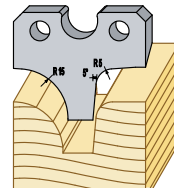

SKU: 94286

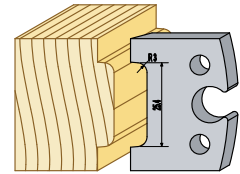

SKU: 94295

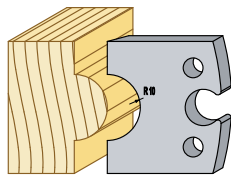

SKU: 94271

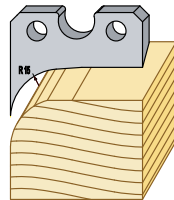

SKU: 94279

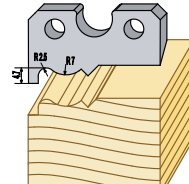

SKU: 94287

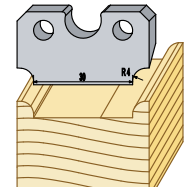

SKU: 94296

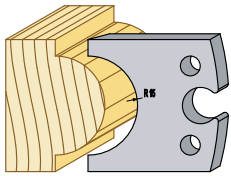

SKU: 94272

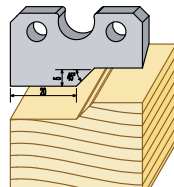

SKU: 94280

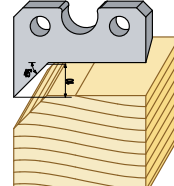

SKU: 94288

Only Solo plane

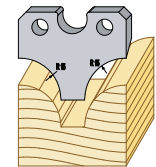

SKU: 94297

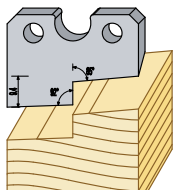

SKU: 94273

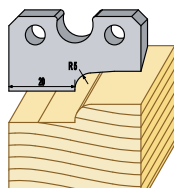

SKU: 94281

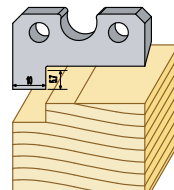

SKU: 94290

Only Solo plane

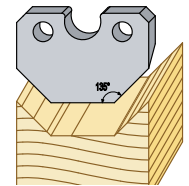

SKU: 94298

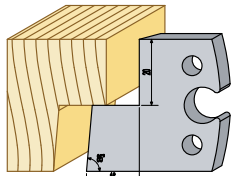

SKU: 94274

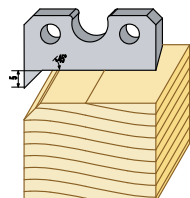

SKU: 94282

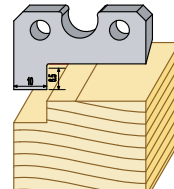

SKU: 94291

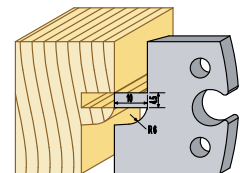

SKU: 94299

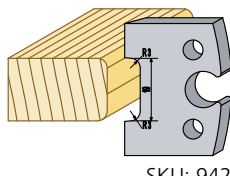

SKU: 94275

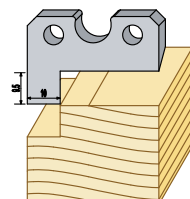

SKU: 94283

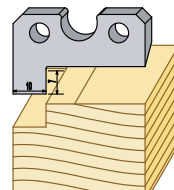

SKU: 94292

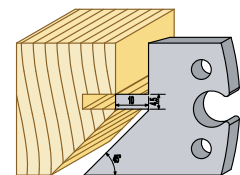

SKU: 94300

HSS MOULDING KNIVES 40X4MM

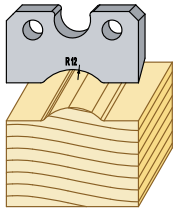

SKU: 94301

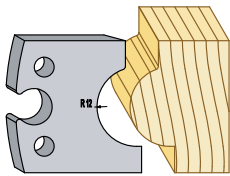

SKU: 94302

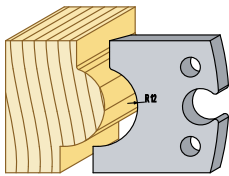

SKU: 94303

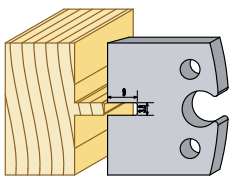

SKU: 94304

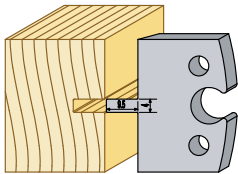

SKU: 94305

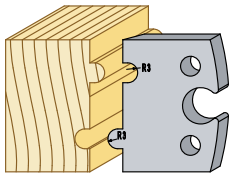

SKU: 94306

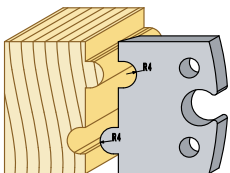

SKU: 94308

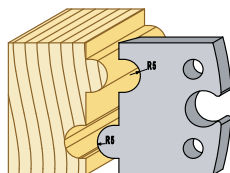

SKU: 94310

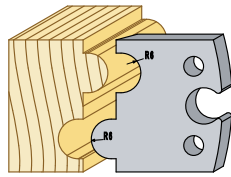

SKU: 94312

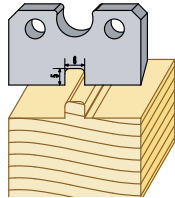

SKU: 94314

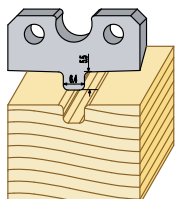

SKU: 94315

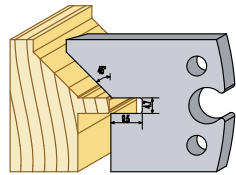

SKU: 94316

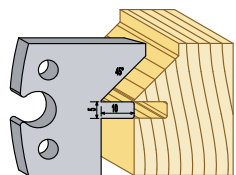

SKU: 94317

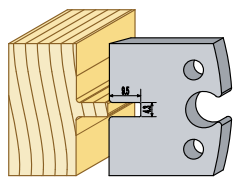

SKU: 94318

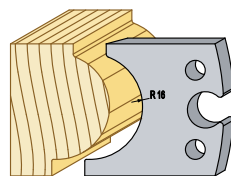

SKU: 94319

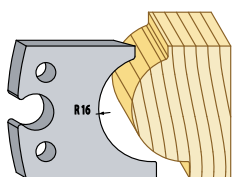

SKU: 94321

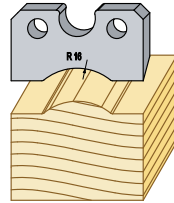

SKU: 94322

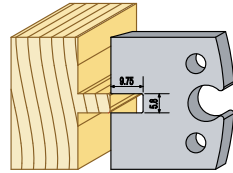

SKU: 94323

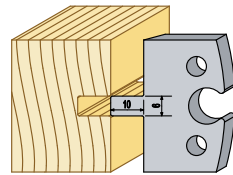

SKU: 94324

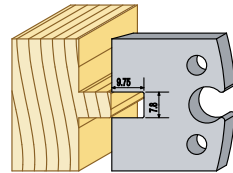

SKU: 94325

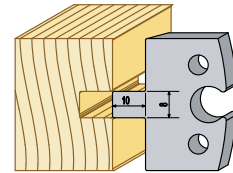

SKU: 94326

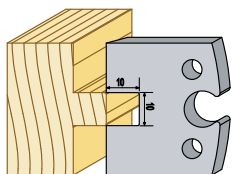

SKU: 94327

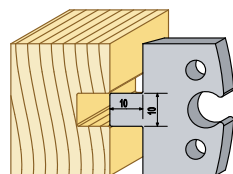

SKU: 94328

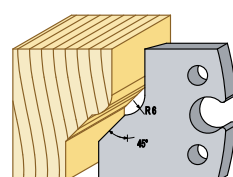

SKU: 94329

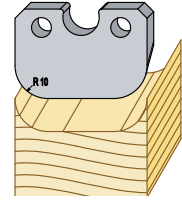

SKU: 94331

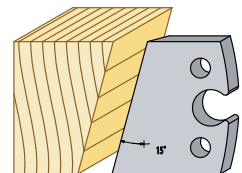

SKU: 94332

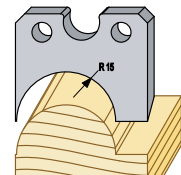

SKU: 94333

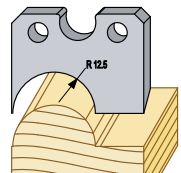

SKU: 94334

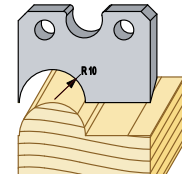

SKU: 94335

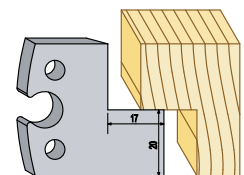

SKU: 94336

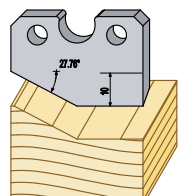

SKU: 94337

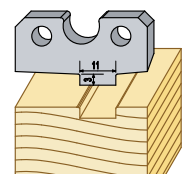

SKU: 94338

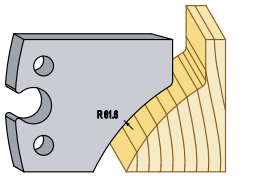

SKU: 94339

Designed for The Solo planer

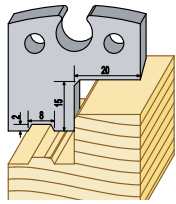

SKU: 94349

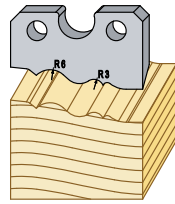

SKU: 94357

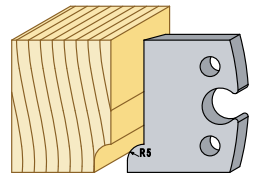

SKU: 94365

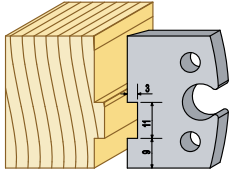

SKU: 94340

Designed for The Solo planer

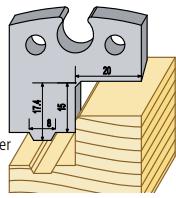

SKU: 94350

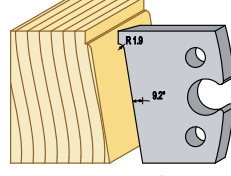

SKU: 94358

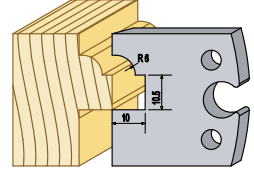

SKU: 94366

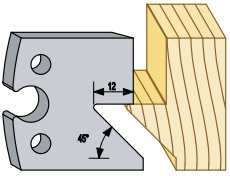

SKU: 94341

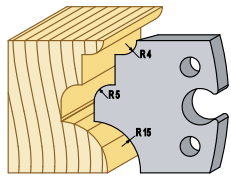

SKU: 94351

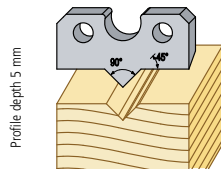

SKU: 94359

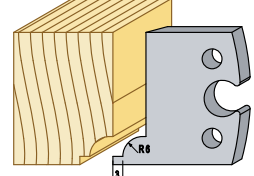

SKU: 94367

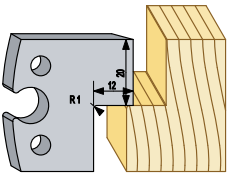

SKU: 94342

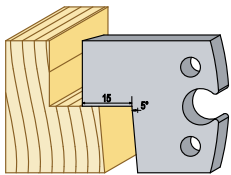

SKU: 94352

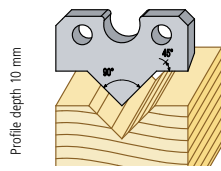

SKU: 94360

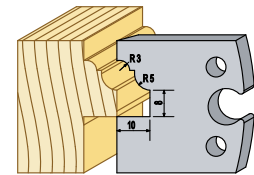

SKU: 94368

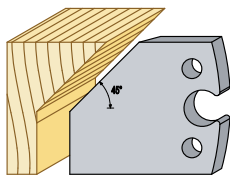

SKU: 94343

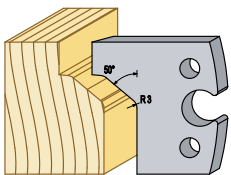

SKU: 94353

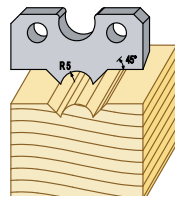

SKU: 94361

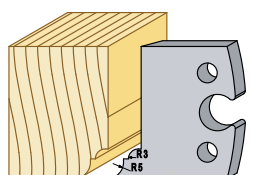

SKU: 94369

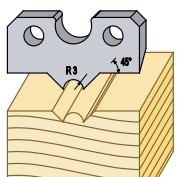

SKU: 94345

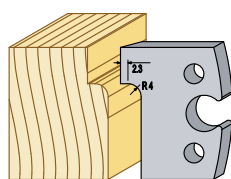

SKU: 94354

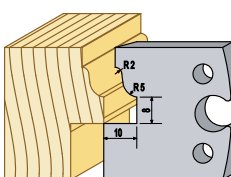

SKU: 94362

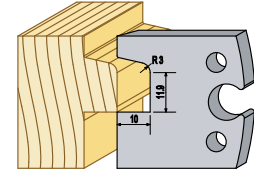

SKU: 94370

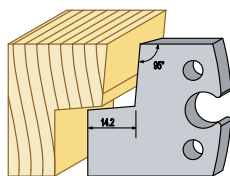

SKU: 94347

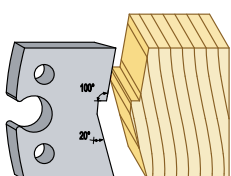

SKU: 94355

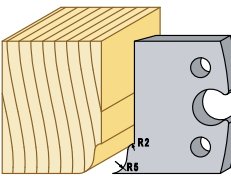

SKU: 94363

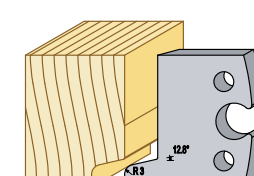

SKU: 94371

Designed for The Solo planer

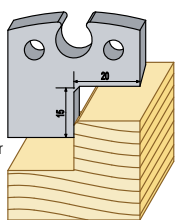

SKU: 94348

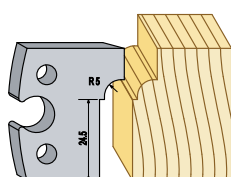

SKU: 94356

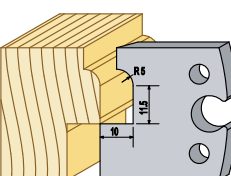

SKU: 94364

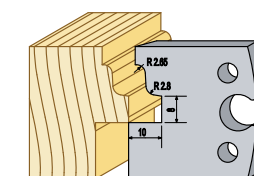

SKU: 94372

HSS MOULDING KNIVES 40X4MM

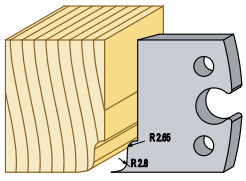

SKU: 94373

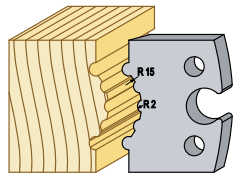

SKU: 94381

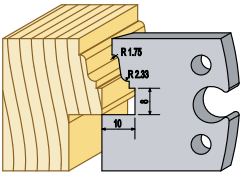

SKU: 94374

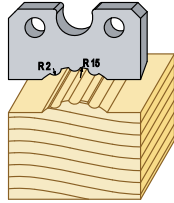

SKU: 94382

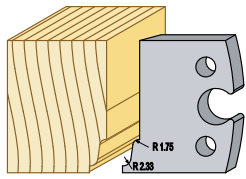

SKU: 94375

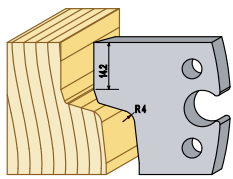

SKU: 94383

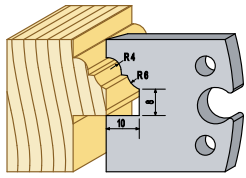

SKU: 94376

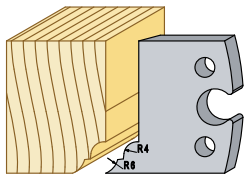

SKU: 94377

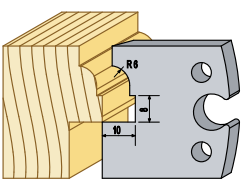

SKU: 94378

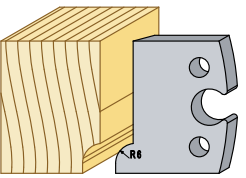

SKU: 94379

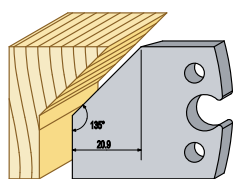

SKU: 94380

50 MM

HSS MOULDING KNIVES 50X4MM

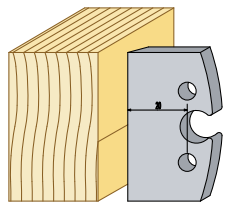

Also available in 9500-16, 9500-24, 9500-32
SKU: 9500-20

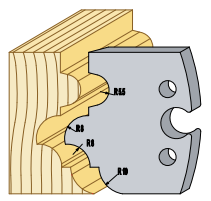

SKU: 95001

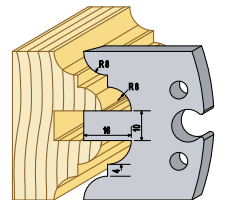

SKU: 95002

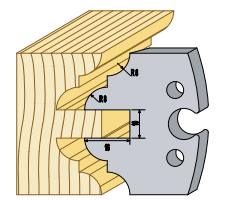

SKU: 95003

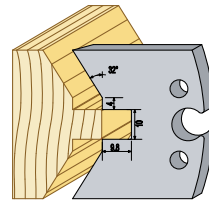

SKU: 95004

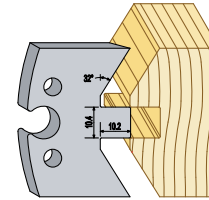

SKU: 95005

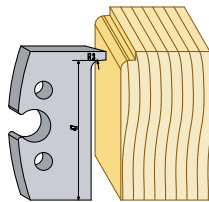

SKU: 95006

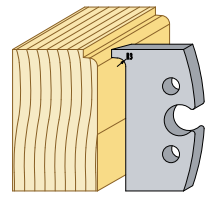

SKU: 95007

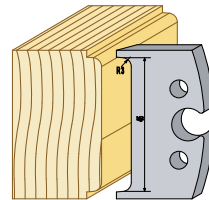

SKU: 95008

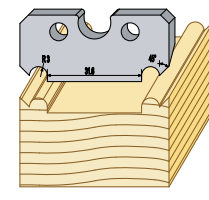

SKU: 95009

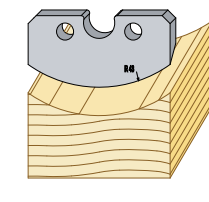

SKU: 95010

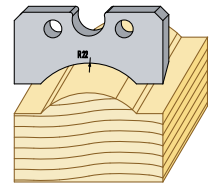

SKU: 95011

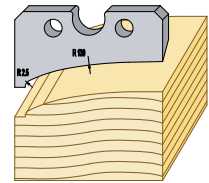

SKU: 95012

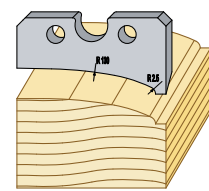

SKU: 95013

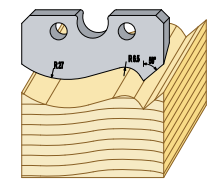

SKU: 95014

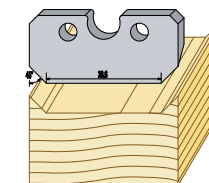

SKU: 95015

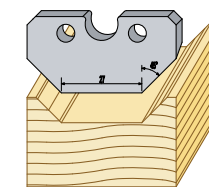

SKU: 95016

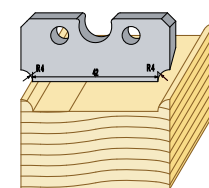

SKU: 95017

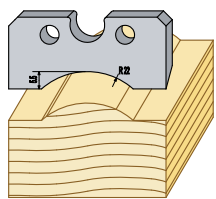

SKU: 95018

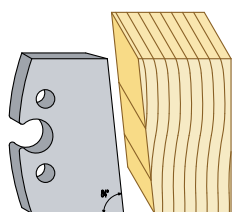

SKU: 95025

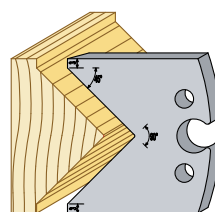

SKU: 95032

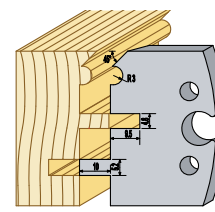

SKU: 95040

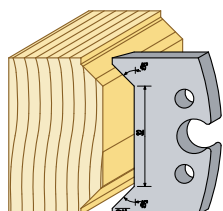

SKU: 95019

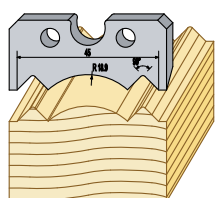

SKU: 95026

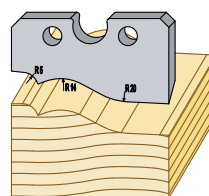

SKU: 95033

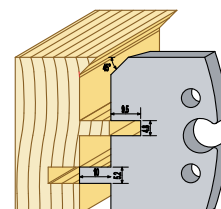

SKU: 95041

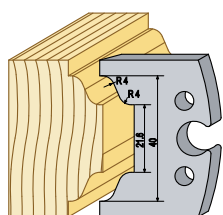

SKU: 95020

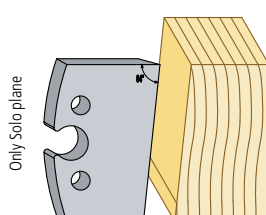

SKU: 95027

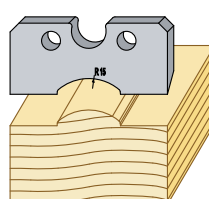

SKU: 95034

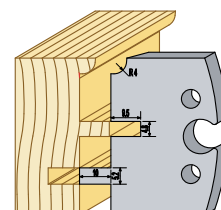

SKU: 95042

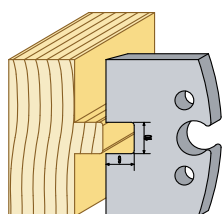

SKU: 95021

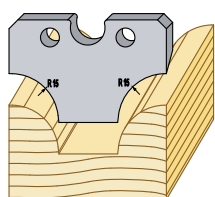

SKU: 95028

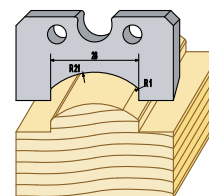

SKU: 95035

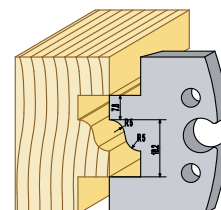

SKU: 95043

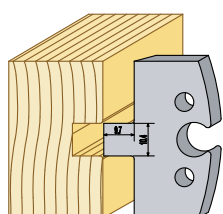

SKU: 95022

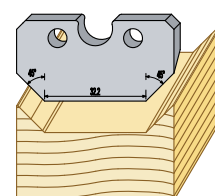

SKU: 95029

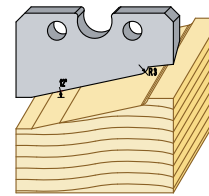

SKU: 95036

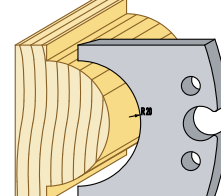

SKU: 95044

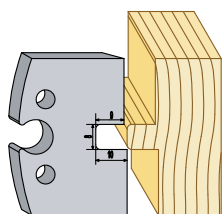

SKU: 95023

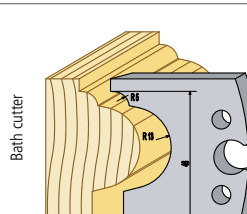

SKU: 95030

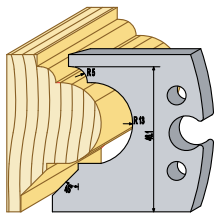

SKU: 95038

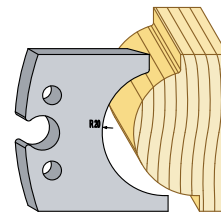

SKU: 95045

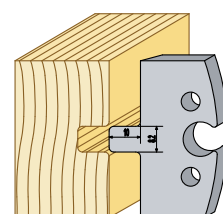

SKU: 95024

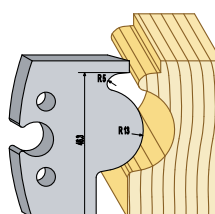

SKU: 95031

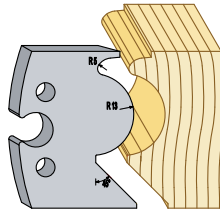

SKU: 95039

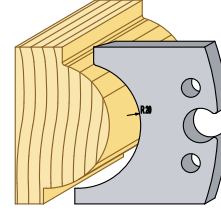

SKU: 95046

HSS MOULDING KNIVES 50X4MM

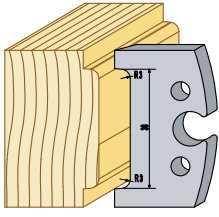

SKU: 95047

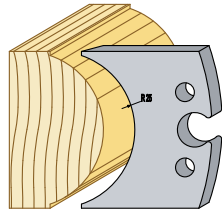

SKU: 95054

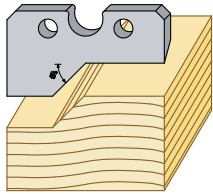

SKU: 95048

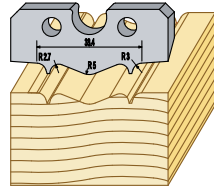

SKU: 95055

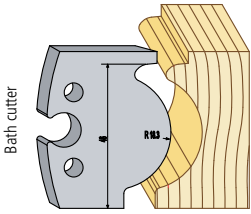

SKU: 95049

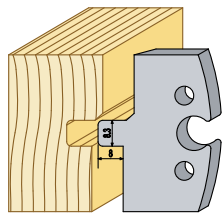

SKU: 95056

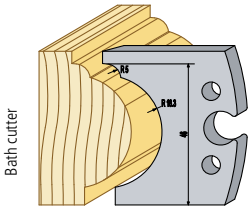

SKU: 95050

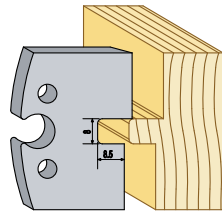

SKU: 95057

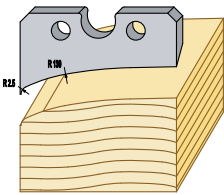

SKU: 95051

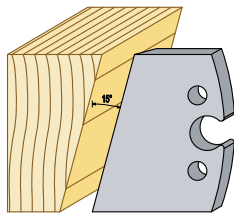

SKU: 95058

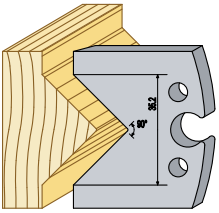

SKU: 95052

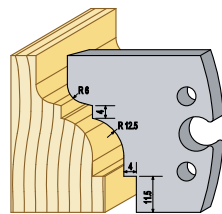

SKU: 95059

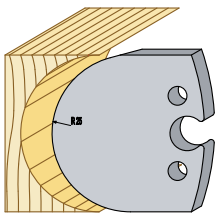

SKU: 95053

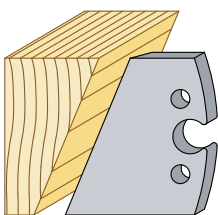

SKU: 95061

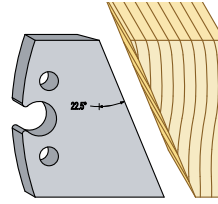

SKU: 95062

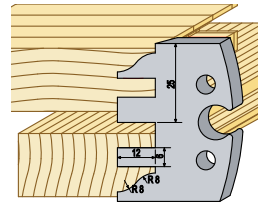

SKU: 95068

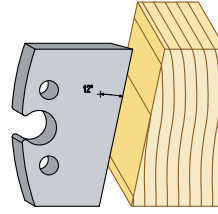

SKU: 95062

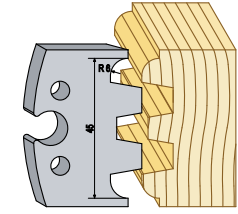

SKU: 95070

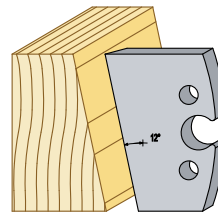

SKU: 95063

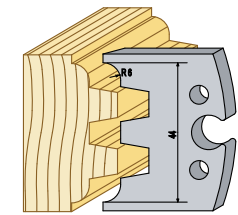

SKU: 95071

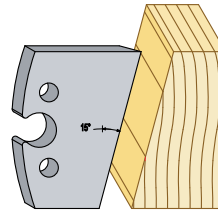

SKU: 95064

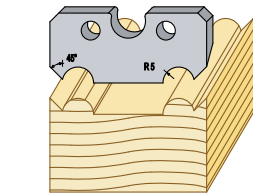

SKU: 95072

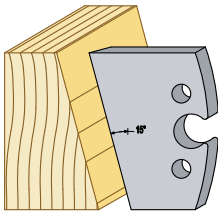

SKU: 95065

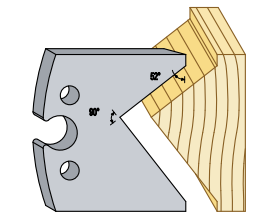

SKU: 95073

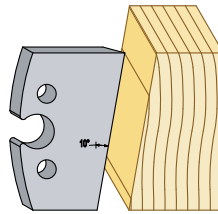

SKU: 95066

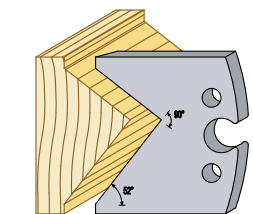

SKU: 95074

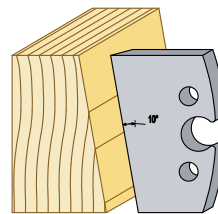

SKU: 95067

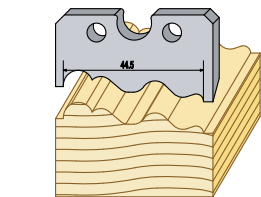

SKU: 95075

60 MM

HSS MOULDING KNIVES 60X4MM

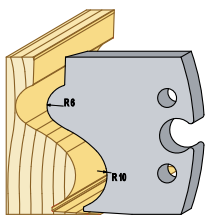

SKU: 95076

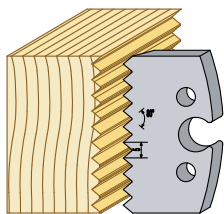

SKU: 95077

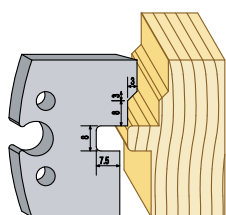

SKU: 95078

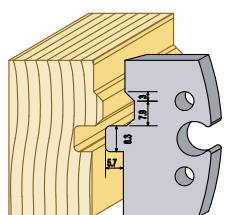

SKU: 95079

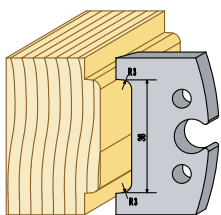

SKU: 95080

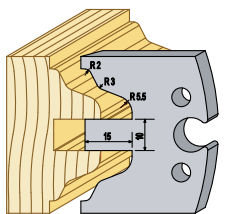

SKU: 95082

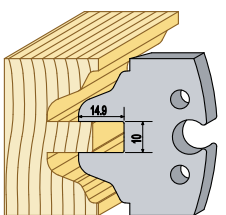

SKU: 95083

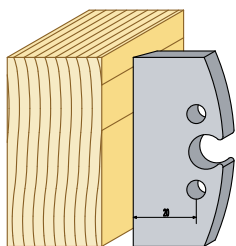

Also available in 9600-16, 9600-24, 9600-32
SKU: 9600-20

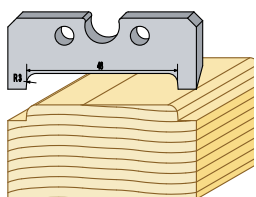

SKU: 96001

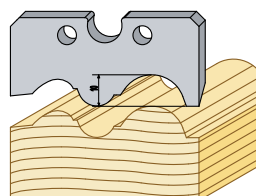

SKU: 96002

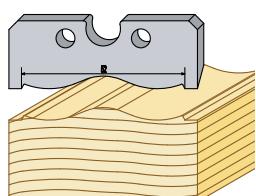

SKU: 96003

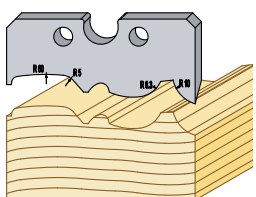

SKU: 96004

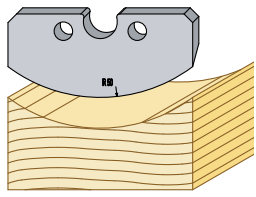

SKU: 96005

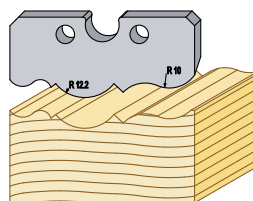

SKU: 96006

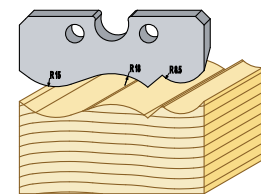

SKU: 96007HSS

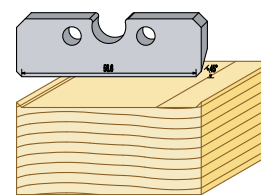

SKU: 96008

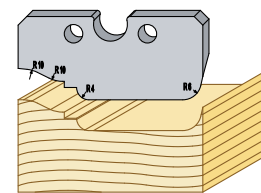

SKU: 96009

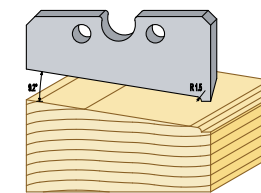

SKU: 96010

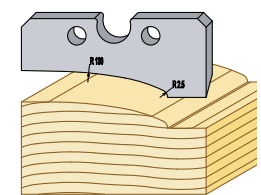

SKU: 96011

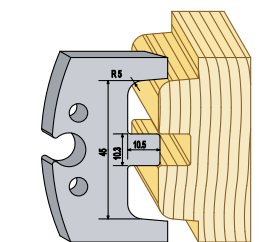

SKU: 96014

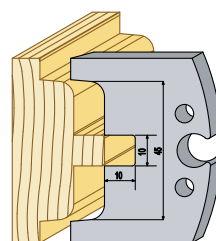

SKU: 96015

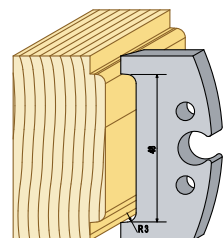

SKU: 96017

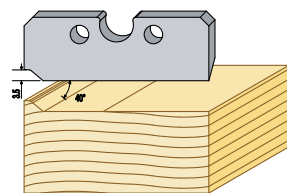

SKU: 96018

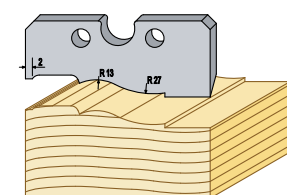

SKU: 96019

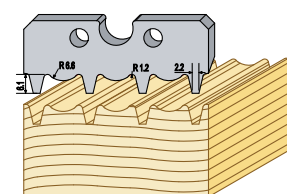

SKU: 96020

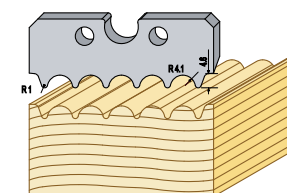

SKU: 96021

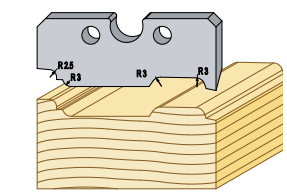

SKU: 96022

100 MM

HSS MOULDING KNIVES 100X4MM

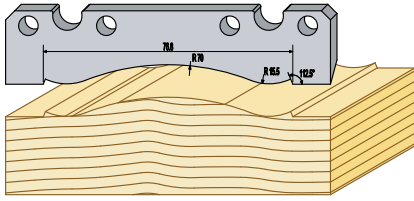

SKU: 91001

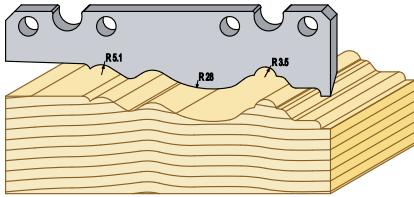

SKU: 91002HSS

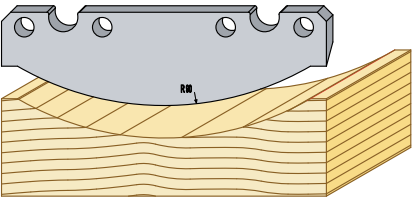

SKU: 91003

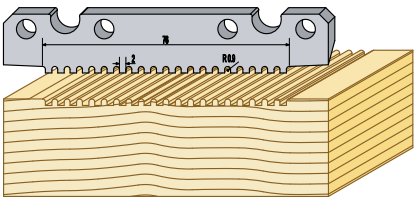

SKU: 91004

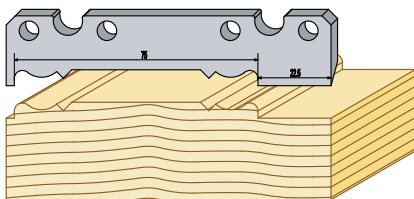

SKU: 91010
Mora panel 95 mm

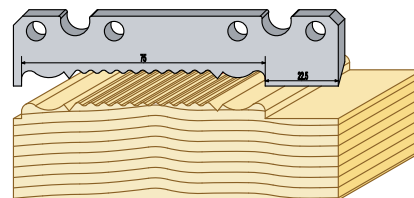

SKU: 91011
Grooved Mora panel 95 mm

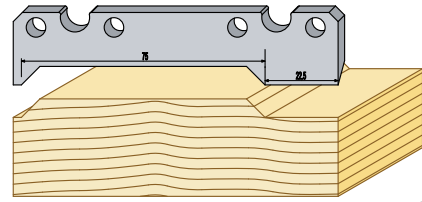

SKU: 91012
Facade panel 95 mm

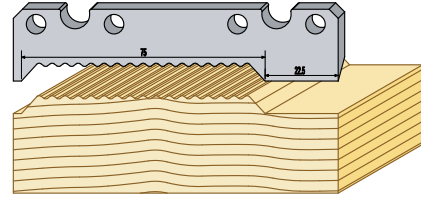

SKU: 91013
Grooved Facade panel 95 mm

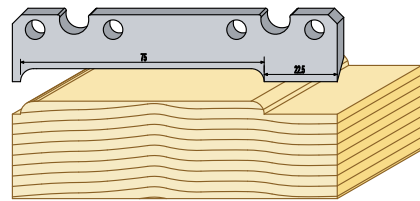

SKU: 91014
Rounded panel 95 mm

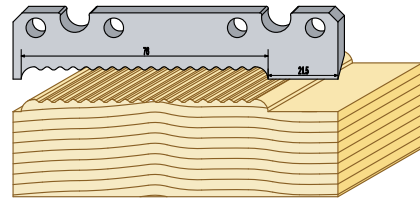

SKU: 91015
Grooved rounded panel 95 mm

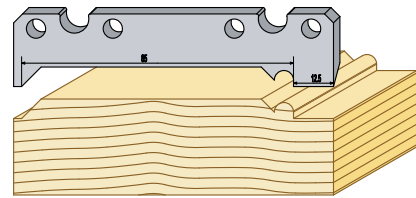

SKU: 91016
Tongued, grooved and beaded timber 95 mm

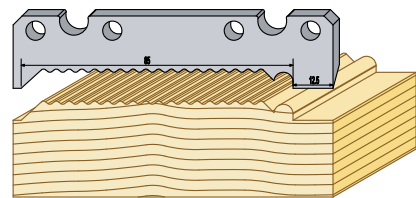

SKU: 91017
Tongued, grooved and beaded timber 95 mm

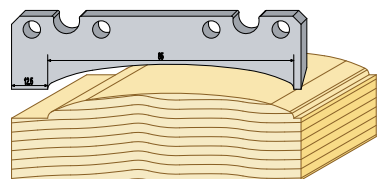

SKU: 91018
Log cabin panel 95 mm

130 MM

HSS MOULDING KNIVES 130X4MM

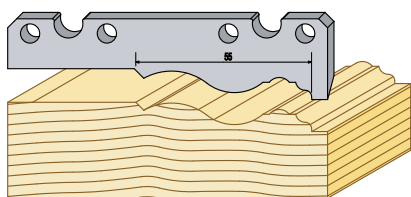

SKU: 91020

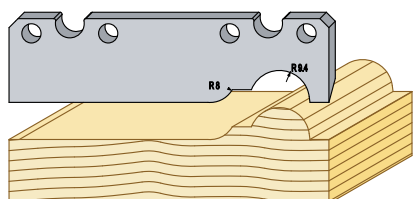

SKU: 91021

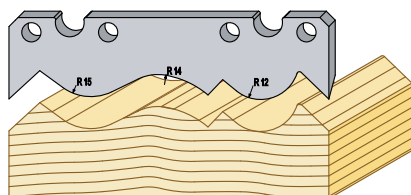

SKU: 91022

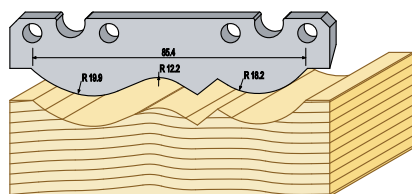

SKU: 91023

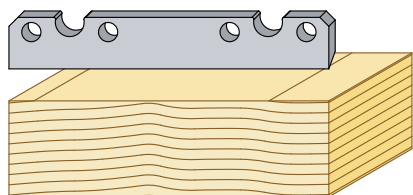

SKU: 91024

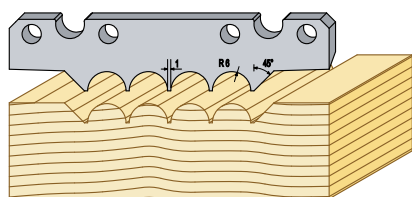

SKU: 91025

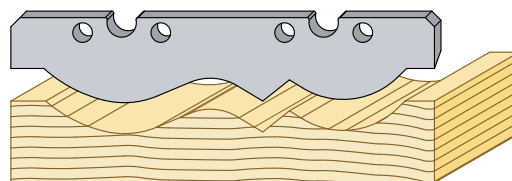

SKU: 91301
Swan neck soffit moulding

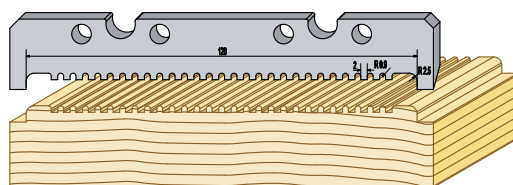

SKU: 91302

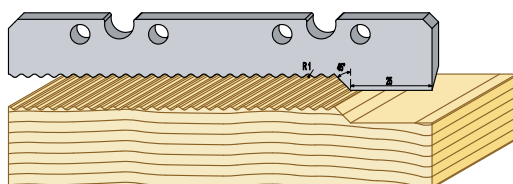

SKU: 91303

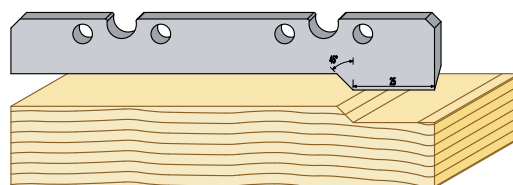

SKU: 91304

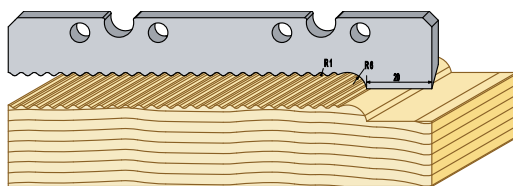

SKU: 91305

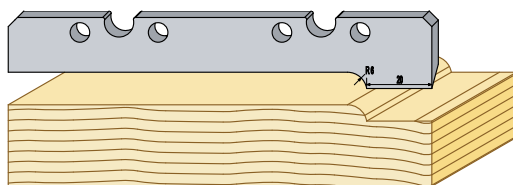

SKU: 91306

HSS MOULDING KNIVES 130X4MM

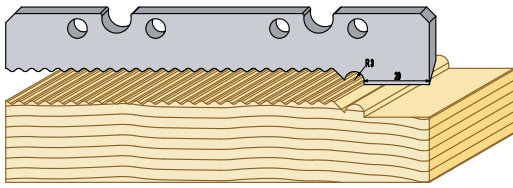

SKU: 91307

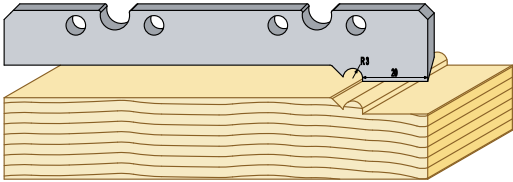

SKU: 91308

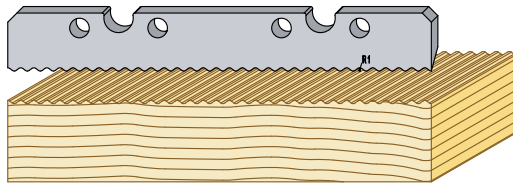

SKU: 91309

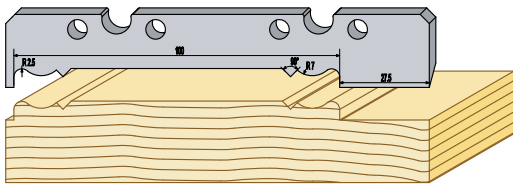

SKU: 91310
Mora panel 120 mm

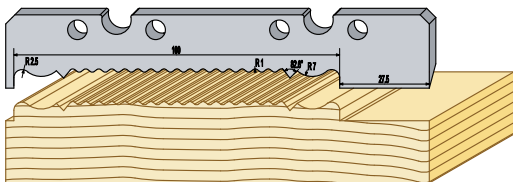

SKU: 91311
Grooved Mora panel 120 mm

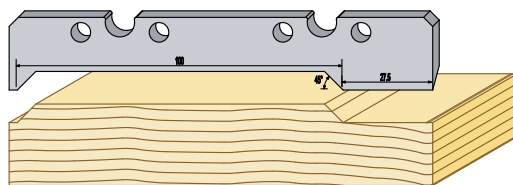

SKU: 91312
Facade panel 120 mm

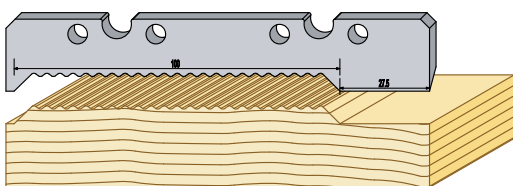

SKU: 91313

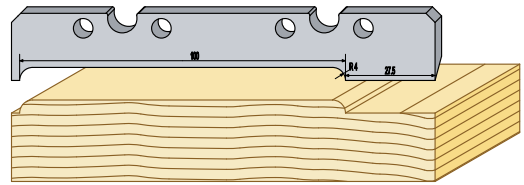

SKU: 91314
Rounded panel 120 mm

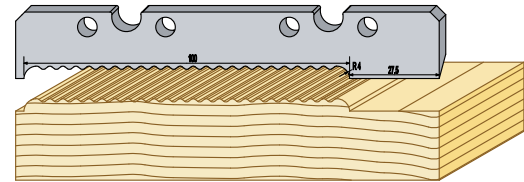

SKU: 91315
Grooved rounded panel 120 mm

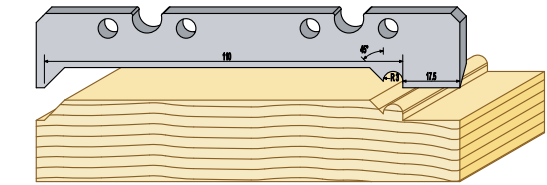

SKU: 91316
Tongued, grooved and beaded timber 120 mm

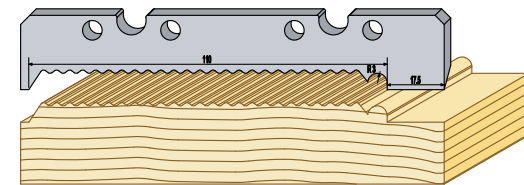

SKU: 91317
Grooved surface, tongued, grooved and beaded timber 120 mm

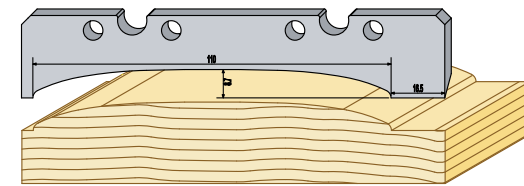

SKU: 91318
Log cabin panel 120 mm

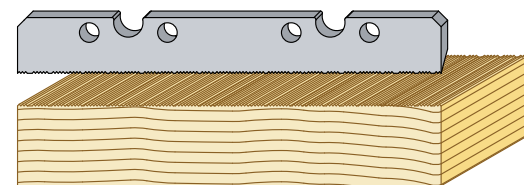

SKU: 91319
"Sawn" surface

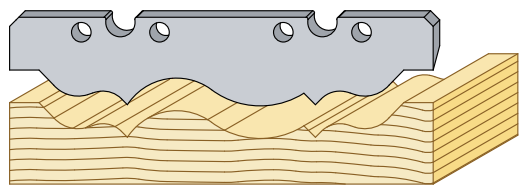

SKU: 91320

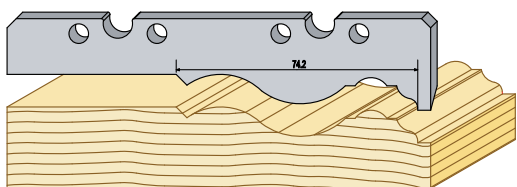

SKU: 91321

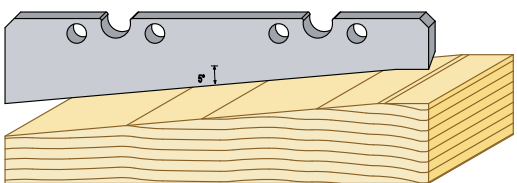

SKU: 91323



SKU: 91324



SKU: 91325



SKU: 91326

KNIFE SETTER FOR CUTTER



Magnetite cutter aligner with micrometer screw for adjustment. Supplied in a protective wooden box.

SKU	Qty
7500-001-0050	1 pair

KNIFE SETTER FOR JOINTER/PLANER



Magnetite cutter aligner for easy adjustment of moulding knives. Supplied in a protective wooden box.

SKU	Qty
7500-001-0051	1 pair

TB90 TIMBER MOULDING KNIVES

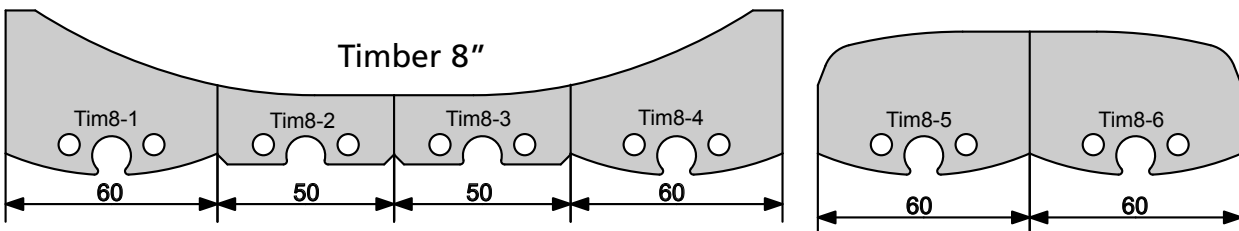
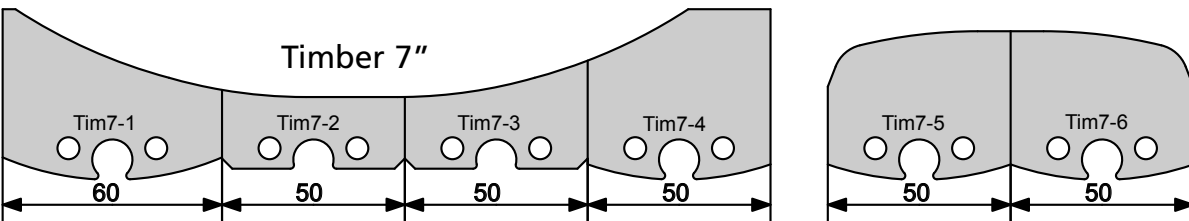
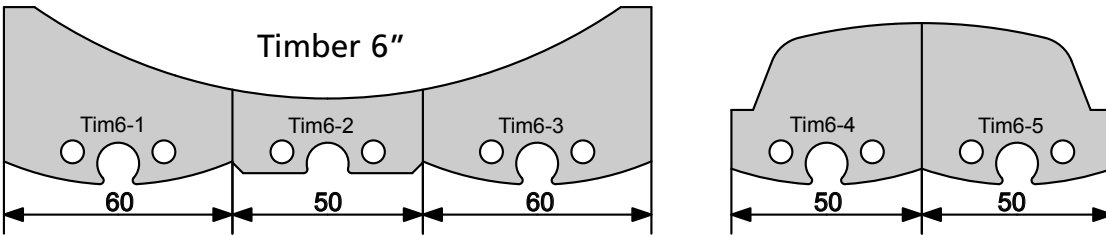
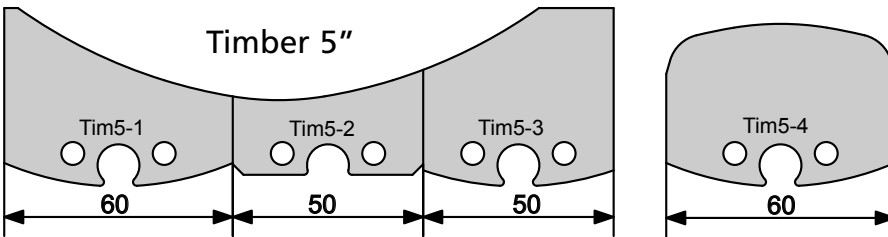
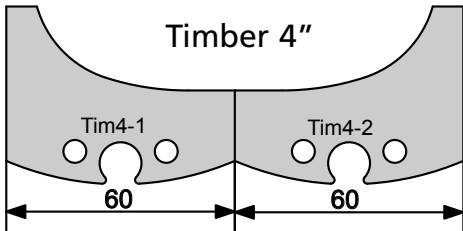
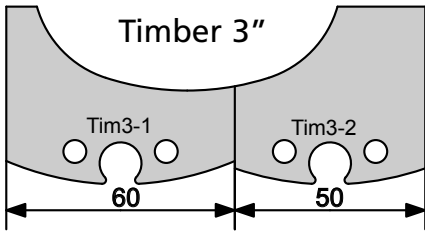

SKU	Description
7000-002-5237	Timber moulding kit 3" incl. wedges
7000-002-5242	Timber moulding kit 4" incl. wedges
7000-002-5212	Timber moulding kit 5" incl. wedges
7000-002-5202	Timber moulding kit 6" incl. wedges
7000-002-5222	Timber moulding kit 7" incl. wedges
7000-002-5232	Timber moulding kit 8" incl. wedges

TIMBER MOULDING KNIFE KIT 6" FOR LM410

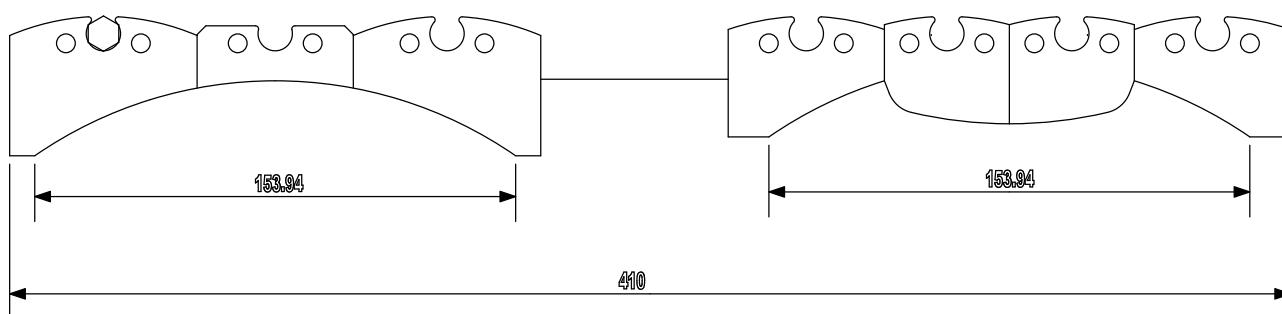

SKU	Description
8020-007-5202	Timber moulding kit 6" incl. wedges

TIMBER MOULDING KNIFE KIT 8" FOR LM410

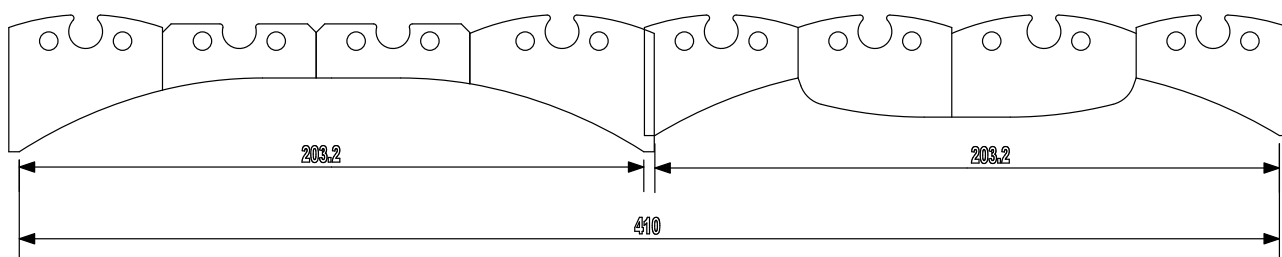

SKU	Description
8020-007-5232	Timber moulding kit 8" incl. wedges

TIMBER MOULDING KNIFE KIT 8 D-LOG 6-8" FOR LM410

SKU	Description
8020-007-5252	Timber moulding kit D-log incl. wedges

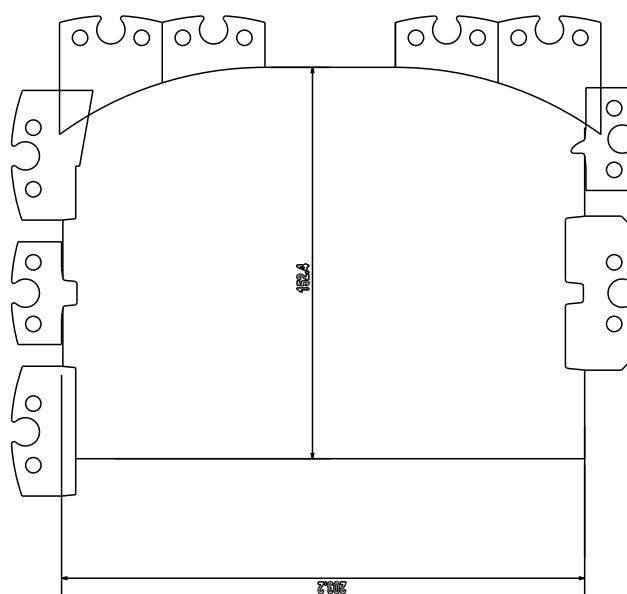

MAKE YOUR OWN PROFILE

CUSTOM-MADE MOULDING KNIVES FOR THE TB SYSTEM

We offer custom-made profiles or grooved knives at a low cost. We draw the profile in a CAD program, that is then transferred to the machine that makes the knives. We need a sketch, drawing or wood sample to do this. **NOTE!** Remember to specify the reference dimensions on the drawings.

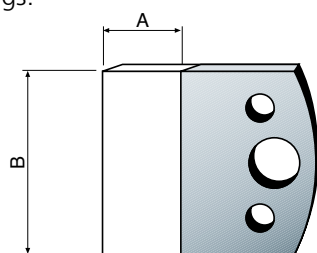

REMEMBER BEFORE YOU ORDER!

1. Choose the right steel blank

You can choose from different grades of steel, depending on the amount of work you intend to do with your blade.

Tool steel

Works well in softwood, such as spruce and pine, and if you are going to process less than 200 linear metres.

HSS 6%

Works well in softwood, such as spruce and pine, and if you are going to process more than 200 linear metres or end grain.

HSS 18%

Should be chosen if you are going to machine hardwoods like oak or beech.

HM

Should be chosen if you are going to machine materials like teak and MDF

Thickness

4 mm

Is the most common thickness, which works for most machining.

5.5 mm

Should be chosen if you have tough machining jobs or large profiles.

2. Order form

Please use our form on the next page, or look through it to see what information we need to expedite your order as quickly and smoothly as possible.

3. Name and address

Please always include your name, address and phone number, so we can contact you if necessary.

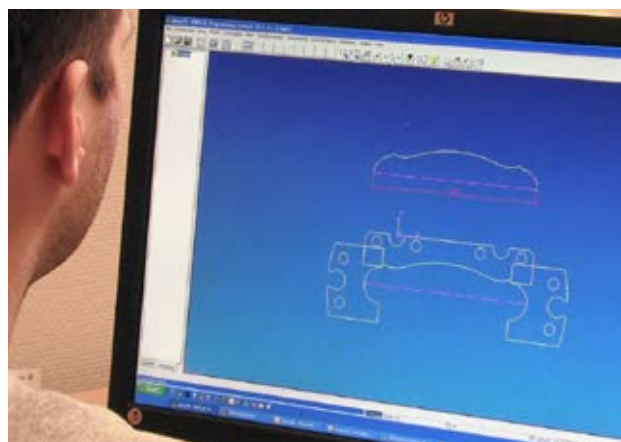

We start by using a CAD program in the computer to draw the profile that you want, using a sketch or other sample from you.

WHAT DOES THE LAW SAY...

... about our steel blanks? Swedish Standard SS-EN874-1 specifies that the profile depth (A) of the knives for our universal cutters must not exceed the table below.

Thickness	SP/Tool Steel	HSS/High Speed Steel	HM/Hard metal
4 mm	17	21	11
5.5 mm	25	25	21

Custom-made TB knives

SKU	Material	Thickness	B (Width)
ø8499	Tool steel	4	40
ø8599	Tool steel	4	50
ø85293	Tool steel	5,5	50
ø8499HSS	HSS 6%	4	40
ø8599HSS	HSS 6%	4	50
ø8699HSS	HSS 6%	4	60
ø81099HSS	HSS 6%	4	100
ø81399HSS	HSS 6%	4	130
ø84499HSS	HSS 18%	4	40*
ø84599HSS	HSS 18%	4	50*
ø84699HSS	HSS 18%	4	60*
ø841099HSS	HSS 18%	4	100*
ø841399HSS	HSS 18%	4	130*
ø85599HSS	HSS 18%	5,5	50
ø85699HSS	HSS 18%	5,5	60
ø8499HM	Hard metal	4	40
ø8599HM	Hard metal	4	50
ø85499HM	Hard metal	5,5	40
ø85599HM	Hard metal	5,5	50
ø8499S	Chip limiter	40	
ø8599S	Chip limiter	50	
ø8699S	Chip limiter	60	

* Only for TB90 and Logosol/Moreten planer/moulders.

ORDER FORM FOR CUSTOM-MADE KNIVES

Machine type:

Cutter type: TB90 / Side cutter* TB98 / Top cutter* TB95 (5.5) Other cutter with matching hole pattern
 Grooved cutter Grooved cutter (WPRS)

Steel grade: Tool steel HSS 6% (softwoods, such as pine or spruce) HSS 18% (hardwoods such as oak or beech) HM (E.g. teak or MDF)

Thickness: 4 mm 5.5 mm Grooved

No. of pairs: 40 mm 50 mm 60 mm 100 mm 130 mm

Grooved insert: Specify length (NOTE each) mm items

If you have specific requirements for knife positioning in your machine, please specify:

.....

Please draw the workpiece the way you feed it into the machine! (vertically/horizontally)

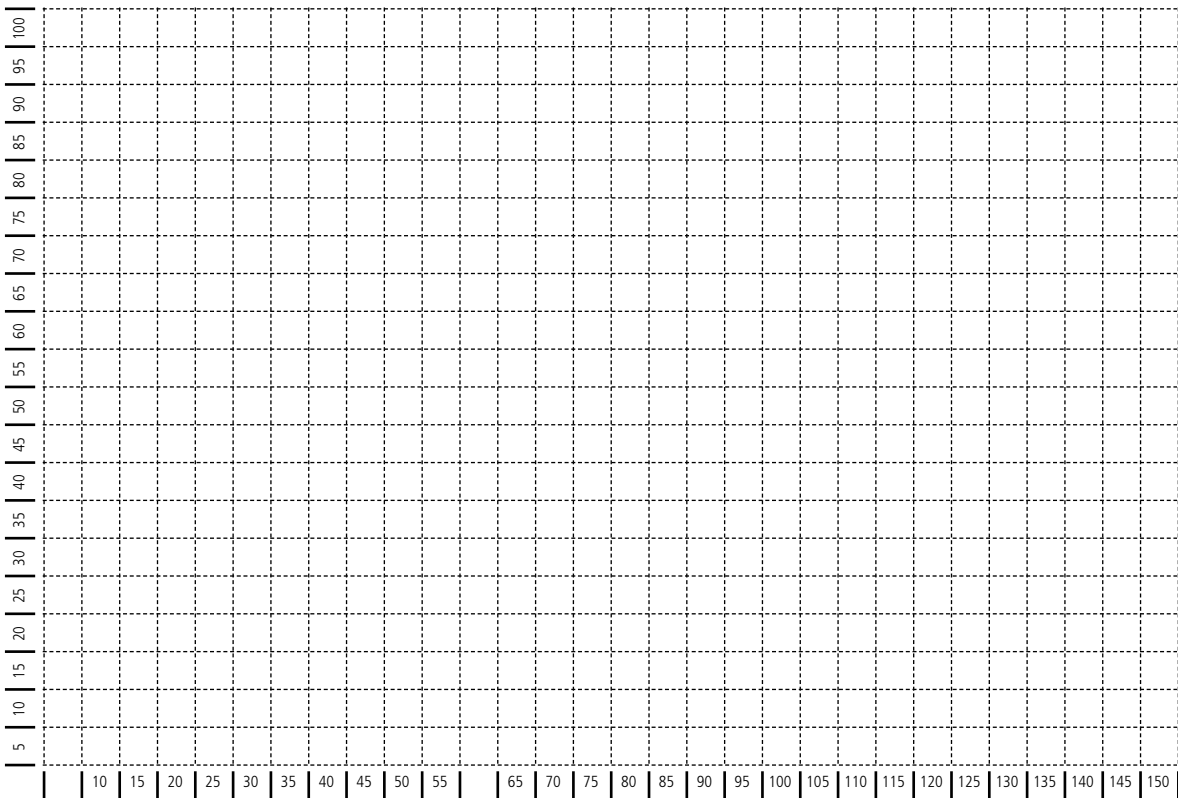

Hole pattern for TB knives
Scale 1:1

* Logosol and Moretens planer/moulders.

Contact information

Company:..... Customer no.:.....

Name:.....

Address:.....

Country:.....

Telephone/Fax:..... Cellphone:.....

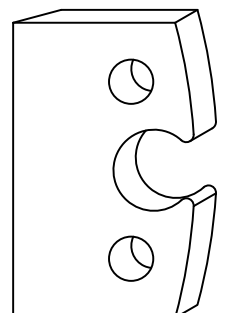

UNIVERSAL CUTTER HEADS



A solid cutter head with attachments for replaceable moulding knives. These are the tools that are normally used in Logosol's planer/moulders, and that are also referred to as the TB system. A moulding knife can be changed quickly, and all knives are designed to have a common minimum flight diameter. This means that you save time, since the fences in the machine does not have to be repositioned when you are changing moulding knives. The flexibility of this system allows most machining operations to be done at a very reasonable price.

TB90 CUTTER HEAD

- Suits all stationary routers, with 20 or 30 mm spindle standard. Can also be used for side spindles in multi-spindle machines.
- All our TB90 cutter heads can use 40, 50 or 60 mm wide knives.
- TB90-92 cutter heads can be stacked, using a couple of dowels. Part no. 8x20
- The knives are quickly and easily inserted in the cutter head, using pins that ensure that the knives can not come loose, and that they are exactly aligned. Some cutter heads are also available with chip limiters, which reduce the risk of digging-in.

SPARE PARTS TB90 cutter	
Retaining screw	09.613
Wedge	Wedge TB90-92
Retaining dowel	8x20
Set screw	T6SS8x16

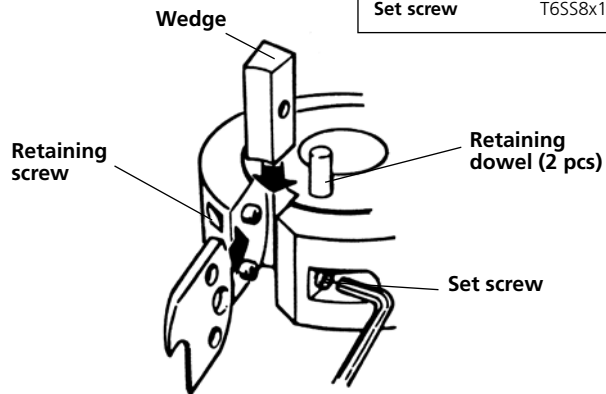

MOULDING KNIVES

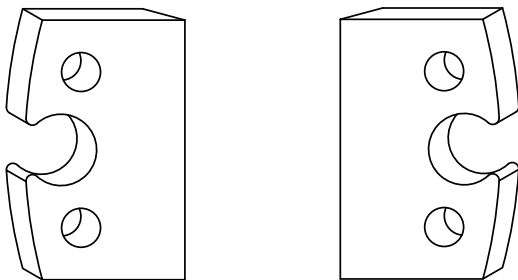

- Moulding knives like these suit our TB90 cutter heads plus other commercially available cutter heads with the same hole pattern.

Steel grade	
Tool steel	Works well in softwood like spruce and pine, if you are going to machine less than 200 linear-metres.
HSS 6%	Works well in softwood like spruce and pine.
HSS 18%	Should be chosen if you are going to machine hardwoods like oak and beech
HM	Should be chosen if you are going to machine materials like teak and MDF

- When you order a chip limiter, put an S at the end of the knife's SKU number.

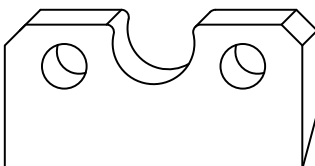

- These knives fit the TB98 cutter head and the top cutter in Logosol and Moreten planers.
- This type of moulding knife, with up to 5 mm projection, can also be used in the bottom cutter in the planers mentioned above.

TB90-84

This is a cutter head that is suitable for machinery with smaller table opening. Another advantage of this cutter head is that it can work on smaller radii. Delivered with a pair of 40 mm wide rabbeting knives.

SKU	Material	Dia.	Height	Blade	Hole	Thickness, blade
TB90-84-20	Aluminium	78	40	2	20	4
TB90-84-30	Aluminium	78	40	2	30	4



MEC

WP90 WITH CHIP LIMITER

An aluminium cutter head, which gives a very low weight. The cutter has a chip limiter to reduce dig-in and kick-back (max. chip thickness 1.1 mm). When you order a chip limiter, put an S at the end of the SKU number. Delivered with a pair of 40 mm wide rabbeting knives and chip limiters.

SKU	Material	Dia.	Height	Blade	Hole	Thickness, blade
WPTB90-98S	Aluminium	100	40	2+chip limiter	30	4



MAN

TB90-92

The TB90-92 is an aluminium cutter head, which gives it a very low weight. The cutter is designed for indexable inserts, SKU no. **HM-9000**. Delivered with a pair of 40 mm wide rabbeting knives.

SKU	Material	Dia.	Height	Blade	Hole	Thickness, blade
TB90-92	Aluminium	88	40	2	30	4

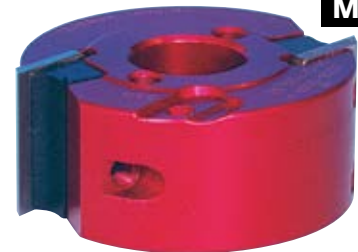

MEC

TB90-140

An aluminium cutter head, an excellent choice for machining tenons. Delivered with a pair of 40 mm wide rabbeting knives.

SKU	Material	Dia.	Height	Blade	Hole	Thickness, blade
TB90-140	Aluminium	138	40	2	30	4

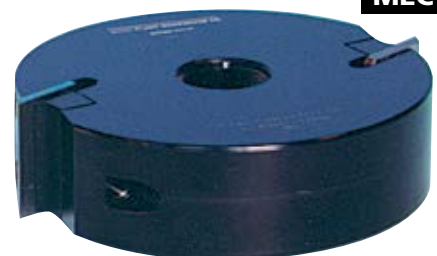

MEC

UNIVERSAL CUTTER HEAD TB90-92 STEEL

TB90-92 steel is a zinc plated, very durable steel cutter. Suitable for tough jobs. Delivered with a pair of 50 mm wide rabbeting knives.

SKU	Material	Dia.	Height	Blade	Hole	Thickness, blade
TB90-92 Steel	Steel	88	40	2	30	4-5,5

MEC



UNIVERSAL CUTTER HEAD TB90-92 Z4

TB90-92 Z4 is a zinc plated steel cutter head with 4 knives. Four knives means that you can increase the feed rate of the machine, and still maintain an excellent finish. Delivered with four 50 mm wide rabbeting knives.

SKU	Material	Dia.	Height	Blade	Hole	Thickness, blade
TB90-92 Z4	Steel	88	40	4	30	4-5,5

MEC

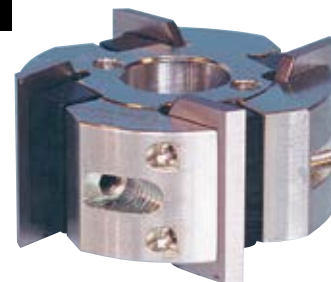

UNIVERSAL CUTTER TB912-92

Black chromed universal cutter head, steel. The cutter head is 120 mm high and works with both 5.5 and 4 mm thick knives. Intended for 130 mm moulding knives. Delivered without knives.

SKU	Material	Dia.	Height	Blade	Hole	Thickness, blade
TB912-92	Steel	88	120	2	30	4-5,5

MEC



SAFETY CUTTER TB912-92S

Black chromed safety cutter head, steel. The cutter head can be fitted with a chip limiter to reduce dig-in and kick-back (max. chip thickness 1.1 mm). When you order a chip limiter, put an S at the end of the SKU number. The cutter head is 120 mm high and works with both 5.5 and 4 mm thick knives. Intended for 130 mm moulding knives. Delivered without knives.

SKU	Material	Dia.	Height	Blade	Hole	Thickness, blade
TB912-92S	Steel	88	120	2+chip limiter	30	4-5,5

MAN



SAFETY CUTTER HEAD TB90-140S

A steel safety cutter head that is excellent for machining mortises. Delivered with 1 pair of 40 mm rabbeting knives and chip limiters. The cutter head is included in the TB9 Window kit.

SKU	Material	Dia.	Height	Blade	Hole	Thickness, blade
TB90-140S	Steel	138	40	2+chip limiter	30	4-5,5
TB90-200S	Steel	198	40	2+chip limiter	30	4-5,5

MAN

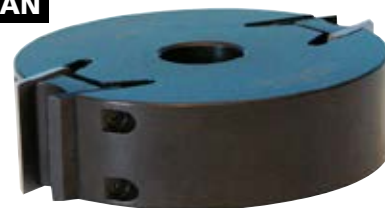

SAFETY CUTTER HEAD TB90-92S

A steel cutter head for tough jobs. The cutter head has a chip limiter to reduce dig-in and kick-back (max. chip thickness 1.1 mm). When you order a chip limiter, put an S at the end of the SKU number. Delivered with a pair of 40 mm wide rabbeting knives and chip limiters.

SKU	Material	Dia.	Height	Blade	Hole	Thickness, blade
TB90-92S	Steel	88	40	2+chip limiter	30	4-5,5

MAN

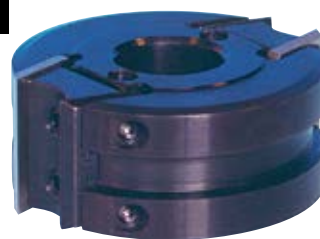

TB90-120

TB90-120 is a steel cutter head for tougher machining jobs. Delivered with a pair of 40 mm wide rabbeting knives.

SKU	Material	Dia.	Height	Blade	Hole	Thickness, blade
TB90-120	Steel	120	40	2	30	4

MEC



TB90-120 Z4

4-knife cutter head, for a finer workpiece surface or increased feed rate. Delivered with four 40 mm wide rabbeting knives.

SKU	Material	Dia.	Height	Blade	Hole	Thickness, blade
TB90-120Z4	Steel	120	40	4	30	4

MEC



UNIVERSAL CUTTER KITS TB90

Complete basic kits in a practical plastic protective package, containing the most commonly used cutter knives, plus an aluminium TB90-92 universal cutter head.

MEC



SKU	Description
TB90-06	Cutter head + 7 pairs of knives (9000-9006)
TB90-10	Cutter head +11 pairs of knives (9000-9010)
TB90-12	Cutter head +13 pairs of knives (9000-9012)

UNIVERSAL CUTTER KITS TB90S

Complete basic kits in a practical plastic protective package, containing the most commonly used cutter knives, plus a steel TB90-92S universal cutter head. The cutter head has a chip limiter to reduce dig-in and kick-back (max. chip thickness 1.1 mm).

MAN

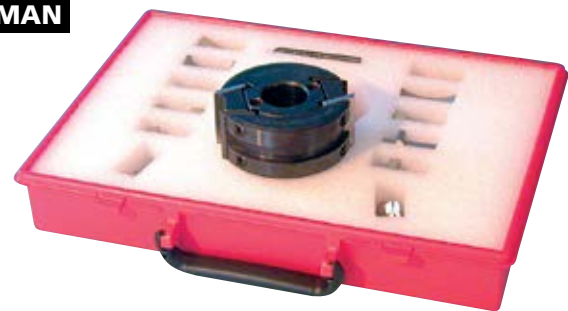

SKU	Description
TB90-06S	Cutter head + 7 pairs of knives (9000-9006)
TB90-10S	Cutter head +11 pairs of knives (9000-9010)
TB90-12S	Cutter knives +13 pairs of knives (9000-9012)

WP90 MILLING CUTTER KIT

A perfect starting kit, complete with 7 pairs of knives and chip limiters for increased safety. The cutter head is made from high quality aluminium, with a standard hole pattern which offers a very wide selection of knives.

MAN

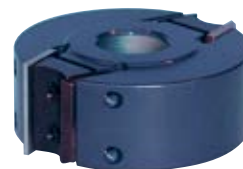

Accompanying profiles

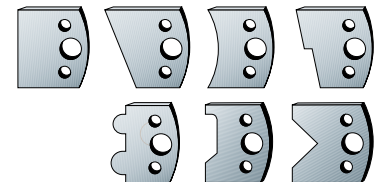

SKU	Dia.	Hole	No. of inserts	Hole diameter
WPTB90-06S	100	40	2+2	30

HM INDEXABLE RABBETING CUTTER KIT

Using TB90-92 and this indexable hard metal insert kit, you can machine chipboard and other abrasive materials. The auxiliary blade in the kit reduces the risk that the material will splinter.

SKU	Description
HM-9000	2 Holders for indexable inserts
L401	2 HM indexable inserts, 40x12x1.5 mm
L141	2 HM auxiliary blades, 14x14x1.2 mm

BALL BEARING RING

Suits TB90-92.

SKU	Diameter	Height
47093	93,5	15

BALL BEARING

For the above ball bearing ring.

SKU	External diameter	Height
47093	55	30

KNIFE GIBS

Spare part gibs for the TB89 cutter head.

SKU	Description
99-1318-3	Gib, 38mm for TB98
99-1318-82	Gib, 100mm for TB98
99-1318-2	Gib, 180 mm for TB98



For installing TB90 knives in Moreten Logosol planer/moulders in the top and bottom cutters. Supplied in pairs.

SKU	Description
7000-000-9502	Standard

Adjustable gib that allows the knife to be adjusted ± 2 mm in height. Supplied in pairs.

SKU	Description
7000-000-9506	Adjustable gib

Narrow gib that allows 5.5 thick knives to be used in Moreten Logosol planer/moulders in the top and bottom cutters. Can also be used to install 100 mm and 130 mm knives in the Logosol SH230. Supplied in pairs.

SKU	Description
7000-000-9508	Narrow gib

For installing TB90 knives in Logosol PH360 in the top cutter. Supplied in pairs.

SKU	Description
KIL360-048	Standard for top cutter PH360

TB98 UNIVERSAL CUTTER HEAD

This cutter head gives you an excellent opportunity for machining neat, unique profiles with your planer/moulder or vertical milling machine in a simple, rational manner.

The TB98 cutter head can be used with advantage to make fully profiled mouldings in one and the same operation. We have illustrated some of the possibilities in the "Combinations" section (see page 102).

The cutter head can be installed in most planer/moulders or stationary milling machines.

TB98 Universal Profile Cutter

The TB98 cutter head can be used in combination with planer/moulders or vertically, in stationary milling machines. The cutter head is equipped with two straight HSS knives for flat machining/planing and two grooves that hold four tension gibs, designed for moulding knives from the TB system, adjustable across the entire width of the cutter.

SKU	Dia.	Hole	Width	Z
TB98-100100	100	30	100	2+2
TB98-100120	100	30	120	2+2
TB98-100180	100	30	180	2+2
TB98-120100	120	50	100	2+2
TB98-120180	120	50	180	2+2

Planing knife - extra planing knife of high-speed steel (HSS) for the TB98 cutter head.

SKU	Length	Width	Thick-ness
HSS-100	100	30	3
HSS-180	180	30	3

Reduction sleeve - to adapt the TB98 cutter head to machines with different spindles than above.

SKU	Description
713,104	Reduction sleeve 50-30
713,111	Reduction sleeve 50-35
713,113	Reduction sleeve 50-40

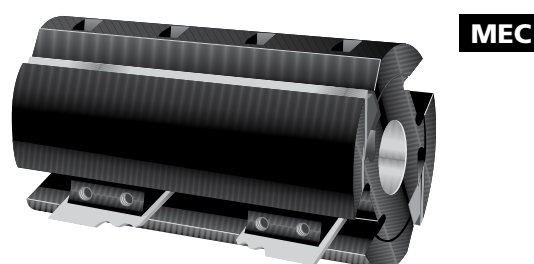
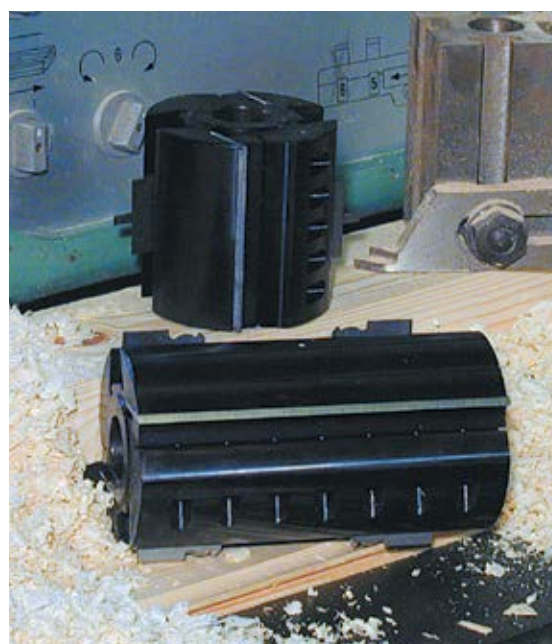

CUTTER HEAD FOR SERRATED BACK KNIVES

Cutter head for serrated back knives MEC. All cutter heads for serrated back knives are supplied without knives.

MEC



Cutter head for serrated back knives MEC Z2

SKU	Dia.	Hole	Height	Blade	Material
TBRS-13710050211	137	50	100	2	Steel



MEC

Cutter head for serrated back knives MEC Z2

SKU	Dia.	Hole	Height	Blade	Material
50110330	120	30	80	2	steel
50110530	120	30	130	2	steel

MEC



Cutter head for serrated back knives MEC Z4

SKU	Dia.	Hole	Height	Blade	Material
TBRS-13718050411	137	50	180	4	steel

MEC



Cutter head for serrated back knives, max. profile depth 25 mm

Cutter heads developed for Logosol planer/moulders

SKU	Dia.	Hole	Height	Blade	Material
TBRS-906030211	90	60	30	2	steel
TBRS-908030211	90	80	30	2	steel
TBRS-9010030211	90	100	30	2	steel
TBRS-9012030211	90	120	30	2	steel

MAN



Cutter head for serrated back knives MAN Z2

SKU	Dia.	Hole	Height	Blade	Material
TBRS-1228030221	122	80	30	2	Steel
TBRS-12210030221	122	100	30	2	Steel
TBRS-12213030221	122	130	30	2	Steel



VERTICAL MILLING CUTTERS



In some routing jobs, fixed cutters are preferable to loose cutter blades. For example, this could be when you want to cut really deep profiles, such as in window manufacture or when you want to remove a lot of material at high speed.

Our vertical milling cutter range contains of a wide selection of professional cutters with indexable inserts or brazed hard metal knives. Log21, our own brand, is a very priceworthy choice. This range, which we have designed ourselves, includes the cutters that we believe meet the basic requirements for vertical milling.

GROOVE, SLOT AND MORTISE CUTTER WITH INDEXABLE HM INSERTS

SKU	D	d	B	Z	V	Extra insert Z	Extra insert V
06,125,004	125	30	4	4	4	09-455	09-470
06,125,006	125	30	6	4	4	09-461	09-470
06,125,008	125	30	8	4	4	09-450	09-475
06,125,010	125	30	10	4	4	09-452	09-475
06,125,012	125	30	12	4	4	09-454	09-475
06,180,008	180	30	8	4	4	09-450	09-475
06,180,010	180	30	10	4	4	09-452	09-475
06,180,012	180	30	12	4	4	09-454	09-475



ADJUSTABLE GROOVE CUTTER WITH INDEXABLE HM INSERTS

01,130,475G has stepless adjustment for width.
01,130,475M has spacer rings for this.

SKU	D	d	B	Z	V	Extra insert Z	Extra insert V
01,130,475G	130	30	4-7,5	4	4	09-455	09-470
01,130,475M	130	30	4-7,5	4	4	09-455	09-470
01,160,815,030G	160	30	15-Aug	4	4	09-450	09-475
01,160,125,030G	160	30	12,5-24	4	4	09-453	09-475

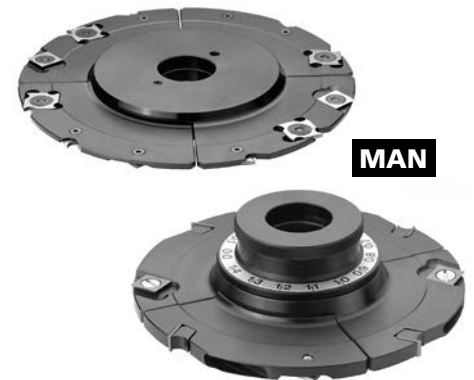

RABBETING CUTTER

Indexable insert cutter with HM inserts. Steel body.

SKU	D	d	B	Z	V	Extra insert Z	Extra insert V
K002-100-30	100	30	30	2	4	L301	L141
K002-100-50	100	30	50	2	4	L501	L141
K002-125-30	125	30	30	2	4	L301	L141
K002-125-50	125	30	50	2	4	L501	L141
02,125,050S	125	30	50	4	4	L501	L141



RABBETING CUTTER

With indexable HM inserts. Aluminium body.

SKU	D	d	B	Z	V	Extra insert Z	Extra insert V
02,090,040	90	30	40	2	4	L401	L141
02,125,030	125	30	30	2	4	L301	L141
02,125,050	125	30	50	2	4	L501	L141
02,125,050A4	125	30	50	4	4	L501	L141



ADJUSTABLE CHAMFER CUTTER

With indexable HM inserts. Adjustable in steps of 7.5°, except K019 which is adjustable in steps of 2.5°.

SKU	D	d	B	Z	G	Extra insert Z
K019-140-50	140	30	50	2	+ - 85°	L501
10,150,050,030,S	150	30	50	2	+ - 90°	L501
10,160,060,030,S	160	30	60	2	+ - 90°	I601



GLULAM CUTTER

With indexable HM inserts.

SKU	D	d	B	Z	Extra insert
13,120,050	120	30	50	2	4,09,1301

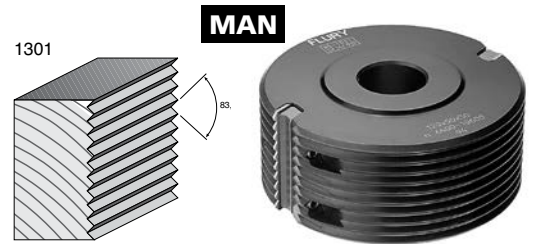

FRIEZE CUTTER WITH INDEXABLE HM INSERT

One and the same cutter body can be used for several different frieze profiles. Delivered with insert no. 1101.

SKU	Dia.	Hole	Height	No. of inserts
11,160,020	160	30	20	2

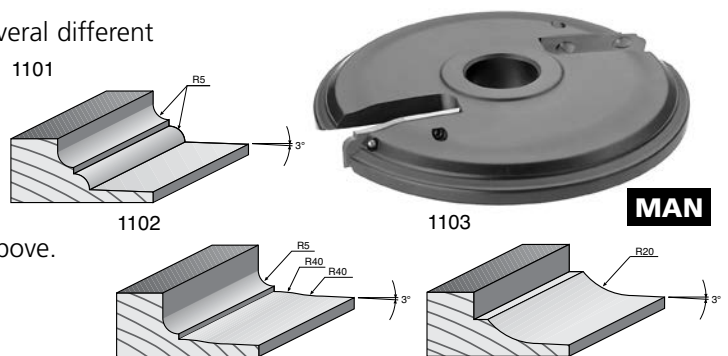

Loose inserts, shape 1 is included in the cutter above.
Order no: 4.09.1101, 4.09.1102, 4.09.1103

MATING PROFILE CUTTER WITH REPLACEABLE HM INSERT

One and the same cutter body can be used for several different mating profiles. Delivered with insert no. 1201.

SKU	Dia.	Hole	Height	No. of inserts
12,120,040	120	30	40	2



Loose insert

Order no: 4.09.1201, 4.09.1202, 4.09.1203, 4.09.1204

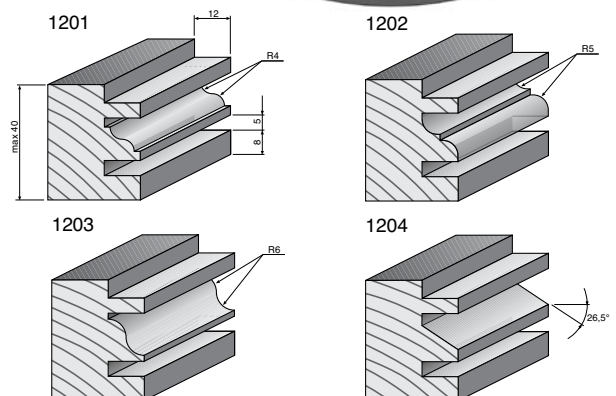

WHAT DOES THE LAW SAY
MAN marked tools must be used in an standard milling machine. Tools marked MEC can be used in a multi-spindle machine like the planer/moulders.

PRO WINDOW CUTTER KIT

For linked casements on outwards opening 1+1 pane windows with 3 different casement profiles.

A kit of 18 different cutter heads with indeaxble hard metal inserts. The kit includes cutter heads for routing the tenons and slots for both casement and window frame.

The shank height and depth of cut are quickly and easily set once, using the accompanying setting gauge for all long routing cuts. The same principle is used for mortise and slot cuts, where only the cutter and spacer rings are changed for each routing task, using the accompanying drawings.



- * Largest tool diameter is 206 mm.
- * Greatest set-up height is 140 mm.
- * Spindle diameter 30 mm

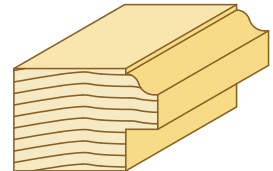
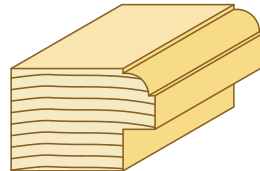
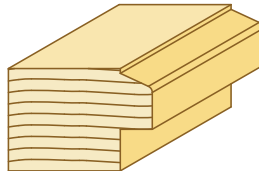

SKU

20200

HELICAL COPYING CUTTER HEAD, WITH INDEXABLE HM INSERTS

SKU	Dia.	Hole	Height	No. of inserts	Extra insert	Ball bearing ring	Accessories
080,120,030	80	30	120	18	L141	476.62.080	47623
080,100,030	80	30	100	16	L141	476.62.080	47623
062,080,030	62	30	80	12	L141		47623
080,080,030	80	30	80	12	L141		47623



MAN

CUPBOARD DOOR EDGE CUTTER HEAD WITH INDEXABLE HM INSERT

One and the same cutter body can be used for several different profiles. Aluminium cutter head. Profile 4 is included.

SKU	Dia.	Hole	Height	No. of inserts	Cut width
14,180,040	180	30	40	2	30,5



MAN



Profile 1
Indexable insert
09.1441



Profile 2
Indexable insert
09.1442



Profile 3
Indexable insert
09.1443



Profile 4
Indexable insert
09.1444



Profile 5
Indexable insert
09.1445

FRIEZE CUTTER HEAD WITH REPLACEABLE HM KNIVES

One and the same cutter body can be used for several different friezes. Aluminium cutter. All profiles are included.

SKU	Dia.	Hole	Height	No. of inserts	Cut width
11,180,040	180	30	40	2+2	69



Profile 1
Indexable insert 09.1113 + 09.1112



Profile 2
Indexable insert 09.1113 + 09.1111



Profile 3
Indexable insert 09.1113 + 09.1110



Profile 4
Indexable insert 09.1114 + 09.1112



Profile 5
Indexable insert 09.1114 + 09.1111



Profile 6
Indexable insert 09.1114 + 09.1110

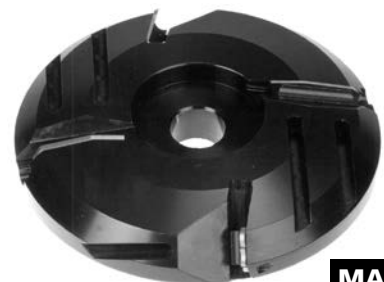

MAN

GLULAM CUTTER HEAD WITH INDEXABLE INSERTS

Aluminium cutter body

SKU	D	d	B	Z	Extra insert Z
18,130,050,030A2	130	30	50	2	09-1850
18,130,060,030A2	130	30	60	2	09-1860



GLULAM CUTTER HEAD WITH INDEXABLE INSERTS

Steel cutter body.

SKU	D	d	B	Z	Extra insert Z
18,130,050,030S2	130	30	50	2	09-1850
18,130,060,030S2	130	30	60	2	09-1860
18,130,080,030S2	130	30	80	2	09-1880



CORNER JOINTING CUTTER HEAD WITH INDEXABLE INSERTS

Aluminium cutter body

SKU	D	d	B	Z	Extra insert Z
18,140,040,030A2	140	30	40	2	09-1801



CORNER JOINTING CUTTER HEAD WITH INDEXABLE INSERTS

Steel cutter body.

SKU	D	d	B	Z	Extra insert Z
18,170,040,030S2	170	30	40	2	10-0026



ADJUSTABLE JOIST AND DECKING CUTTER HEAD

With replaceable knives. Adjustable joist and decking cutter head for thicknesses between 5-62 mm. You can choose to do rounding or chamfering cuts. Replaceable knives with radius 5 and 45° chamfer are included in the kit.

SKU	D	d	B	Z	Extra insert Z
20,HK,19,SET5BG	113	30	-	2	2-5 45G

Also available for spindle diameters up to 50 mm.



ROUNDING CUTTER HEAD WITH REPLACEABLE KNIVES

SKU	D	d	B	Z	R	Extra insert Z
19,120,020,130A	120	30	20	2	3-10	See table
19,140,030,130A	140	30	30	2	12-20	See table

Item 19,120,020,130A is supplied with R8 as standard
 Item 19,140,030,130A is supplied with R12 as standard

Kit

SKU	D	d	B	Z	R
19,120,020,030A	120	30	20	2	3,4,5,6,8,10
19,140,030,030A	140	30	30	2	12,15,18,20

Extra knives

- 09-19103 Profile R=3
- 09-19104 Profile R=4
- 09-19105 Profile R=5
- 09-19106 Profile R=6
- 09-19108 Profile R=8
- 09-19110 Profile R=10
- 09-19112 Profile R=12
- 09-19115 Profile R=15
- 09-19118 Profile R=18
- 09-19120 Profile R=20

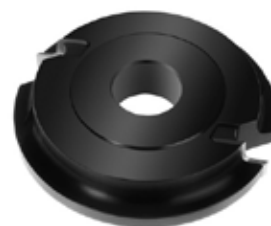

STRAIGHT TONGUE & GROOVE CUTTER HM

For grooves, small mortises and slots.

SKU	Dia.	Hole	Height
A61-120-10	120	30	10
A61-120-12	120	30	12
A61-120-4	120	30	4
A61-120-6	120	30	6
A61-120-8	120	30	8

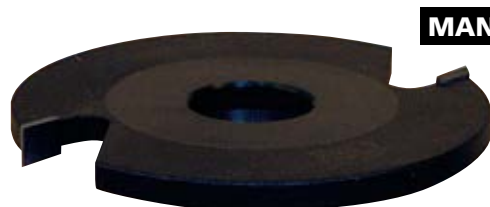
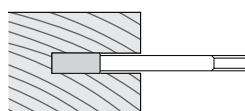

SLOT / MORTISE CUTTER KIT HM

8–16 mm with accompanying spacer rings.

SKU	Dia.	Hole	Height
A62-160	160	30	8–16
A62-200	200	30	8–16

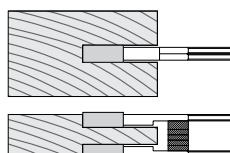

STRAIGHT TONGUE & GROOVE CUTTER HM

For grooves, small mortises and slots.

SKU	Dia.	Hole	Height
WP50104	120	30	4
WP50106	120	30	6
WP50108	120	30	8
WP50110	120	30	10
WP50112	120	30	12



SLOT AND MORTISE CUTTER WITH HM INSERTS

For grooves, mortises and slots.

SKU	Dia.	Hole	Height	Blade	Insert
WP50206	160	30	6	2	2
WP50208	160	30	8	2	2
WP50210	160	30	10	2	2
WP50212	160	30	12	2	2
WP50306	180	30	6	2	2
WP50308	180	30	8	2	2
WP50310	180	30	10	2	2
WP50312	180	30	12	2	2

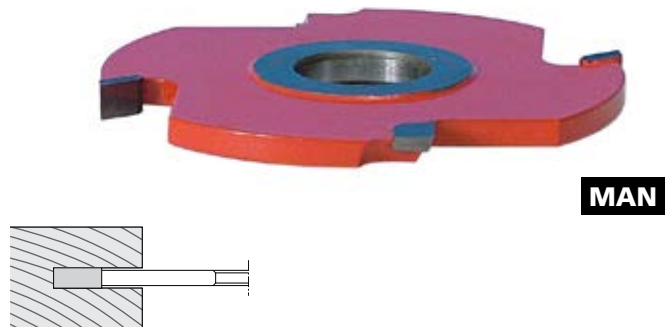

SLOT / MORTISE CUTTER HM

Adjustable between 8-16 mm with accompanying spacer rings.

SKU	Dia.	Hole	Height
WP50501	160	30	8-16
WP50601	200	30	8-16



ADJUSTABLE TONGUE & GROOVE CUTTER HM

Adjustable between 4-8 mm with accompanying spacer rings.

SKU	Dia.	Hole	Height
WP50401	120	30	5-10



ROUNDING CUTTER HM

With hard metal knives, can be used together with template rings.

SKU	Dia.	Hole	Height
Q32-120-R5	100	30	5
Q32-120-R7,5	105	30	7,5
Q32-120-R10	110	30	10
Q27-120-R15	120	30	15

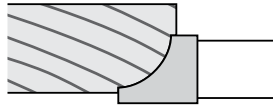

MAN

ROUNDING CUTTER HM

Can be used together with template rings.

SKU	Dia.	Hole	Radius
WP50704	98	30	4
WP50705	100	30	5
WP50775	105	30	7,5
WP50710	110	30	10
WP50715	120	30	15

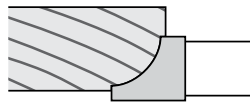

MAN

CORNER JOINING CUTTER HM

Hard metal.

SKU	D	B	b
FS4150011	140	30	30

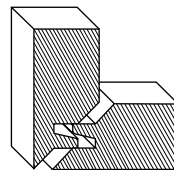

MAN

CORNER JOINING CUTTER HM

Material thickness 16-25 mm.

SKU	D	B	b
WP51101	120	30	30

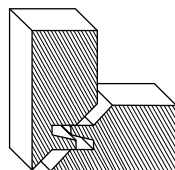

MAN

PROFILE AND MATCHING PROFILE CUTTER KIT HM

For simple and professional routing of kitchen, wardrobe, glazed cabinet and bookshelf doors with material thicknesses between 18.5–22 mm. You do not need to use spacer rings when adjusting the tool. This makes it extra quick and easy to use.

SKU	D	d
J134-116	116	30

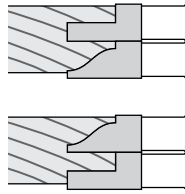

MAN

PROFILE AND MATCHING PROFILE CUTTER KIT, 2 ITEMS HM

For simple and professional routing of kitchen, wardrobe, glazed cabinet and bookshelf doors with material thicknesses between 18.5–22 mm. You do not need to use spacer rings when adjusting the tool. This makes it extra quick and easy to use.

SKU	Dia.	Hole
WP51301	116	30

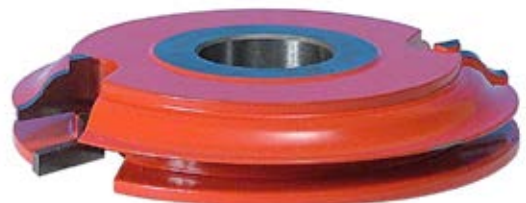
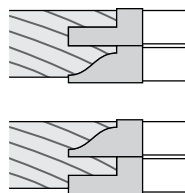

MAN

FRIEZE CUTTER HM

Hard metal.

SKU	D	d	R	G
26-176-160	160	30	8	5

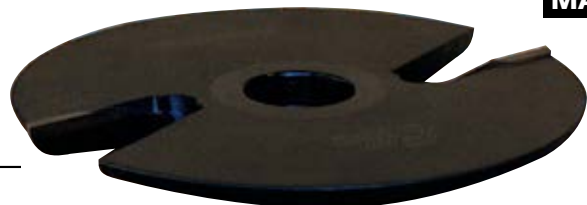

MAN

FRIEZE CUTTER HM

SKU	Dia.	Hole	Radius	G
WP51201	160	30	8	5



MAN

RADIUS CUTTER HM

For rounded corners and roundwood, with variable radius: 4, 6, 8 or 10 mm radius.

SKU	Dia.	Hole	Radius
J176	140	30	4+6+8+10

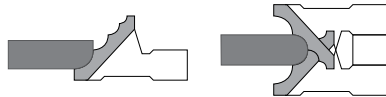

MAN

GLULAM CUTTER HM

To make a strong bonded joint.

SKU	Dia.	d	B
H08-120	120	30	28

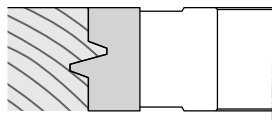

MAN

CHAMFER CUTTER HM

45 degrees.

SKU	Dia.	Hole	Height
V19-120-45	120	30	15

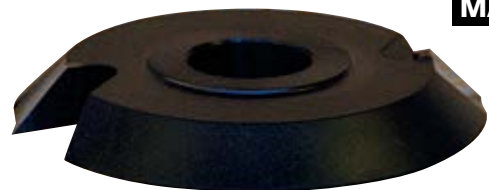
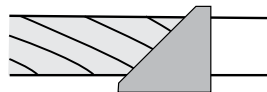

MAN

CHAMFER CUTTER HM

45 degrees.

SKU	Dia.	Hole	Height
WP50801	120	30	15

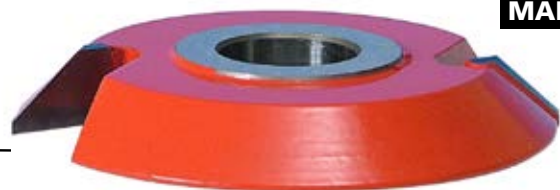
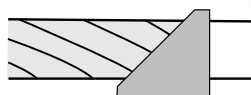

MAN

CHAMFER CUTTER HM

45 degrees.

SKU	Dia.	Hole	Height
WP50802	120	30	15

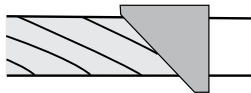

MAN

PROFILE AND MATCHING PROFILE CUTTER KIT, 2 ITEMS HM

A unique cutter kit for making complete kitchen cabinet doors and interior doors, with both mating profiles and panel routing. Material thickness 15-45 mm. You do not need to use spacer rings when adjusting the tool. This makes it extra quick and easy to use.

SKU	Dia.	Hole
J166-160	120	30



Mating profile machining for kitchen cabinet doors 16-22 mm

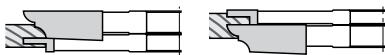

Mating profile machining for kitchen cabinet doors 15-24 mm

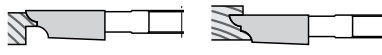

Mating profile machining for kitchen cabinet doors 22-25 mm



Panel routing

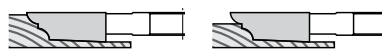

PROFILE AND MATCHING PROFILE CUTTER KIT, 2 ITEMS HM

A unique cutter kit for making complete kitchen cabinet doors and interior doors, with both mating profiles and panel routing. Material thickness 15-45 mm. You do not need to use spacer rings when adjusting the tool. This makes it extra quick and easy to use.

SKU	Dia.	Hole
WP51401	160	30

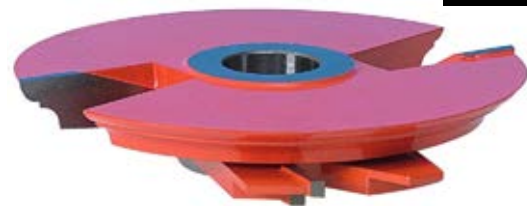

Mating profile machining for kitchen cabinet doors 16-22 mm

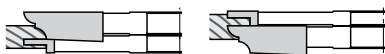

Mating profile routing for kitchen cabinet doors 15-24 mm

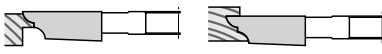

Mating profile machining for kitchen cabinet doors 22-25 mm



Panel routing

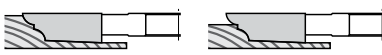

FRIEZE CUTTER HM

SKU	Dia.	Hole	Degrees
WP51202	160	30	5



TAPERED CUTTER KIT HM

For repairing carvel-built boats and wooden floors etc.
Consists of 1 blade and 1 hard metal shank cutter.

SKU
WP52400

Technical data, blade		Technical data, shank cutter	
External diameter	125 mm	Diameter	6.2 mm
Hole	20 mm	Flute length	25 mm
Cut width	6.2 mm	Shank	8 mm
Degrees	3	Degrees	3

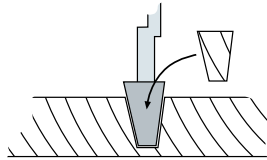

ADJUSTABLE JOIST AND DECKING CUTTER HEAD HM

With 45° chamfered edge. 2 part cutter kit, thickness adjustable between 19 and 50 mm, using the accompanying rings.

SKU	Dia.	Hole	Blade	Height
WP51045	120	30	2+2	30+30

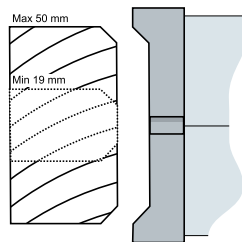

ADJUSTABLE JOIST AND DECKING CUTTER HM

With rounded edge, radius 3 mm. 2 part cutter kit, thickness adjustable between 19 and 50 mm, using the accompanying rings.

SKU	Dia.	Hole	Blade	Height
WP50903	120	30	2+2	30+30

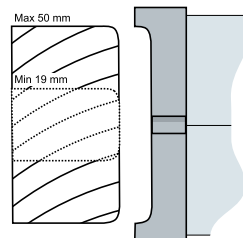

TONGUE CUTTER HEAD HM

Tongued board 6.0 mm

SKU	Dia.	Hole	Blade	Height
WP51501	110	30	4	40

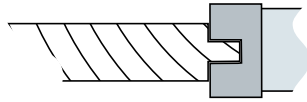

MAN

GROOVE CUTTER HEAD HM

Grooved board 6.4 mm

SKU	Dia.	Hole	Blade	Height
WP51502	110	30	4	40

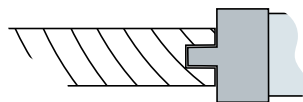

MAN

CLADDING CUTTER KIT

Developed for producing tongue-and-grooved cladding with an un-planed exterior. Complete kit. Contains: 2 pairs of 40 mm HSS inserts (94341HSS & 94342HSS)

SKU
WP52500

Only work with PH260

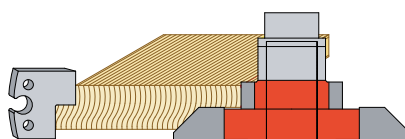
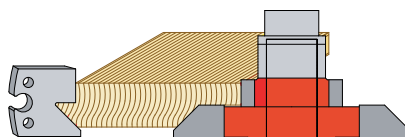

MEC

WP WINDOW KIT

Complete window machining kit, incl. rustic profile, 8 different HM tools for making windows. This tool kit can be used to make conventional coupled casement 2 or 3 pane insulating glass windows with conventional casements and glazing bars. The requirement is that there must be access to a jointer/planer, circular saw and router with a 30 mm spindle.

MAN



SKU
WP50000

Cutters included in WP Window cutter kit

	Dia- meter	Flute length	Blade	Hole		Separate SKU
Tongue & groove cutter, window flashing tongue & groove cutter	100	1	4	30		WP52101
Rounding cutter	98	9	2	30	Radius = 4	WP50704
Double insert cutter	120	15	2	30	Degrees = 45+45	WP51845
Chamfer cutter	120	50	2	30	Degrees = 6	WP51606
Rabbeting cutter with insert	120	50	2	30	Insert = 2+2	WP51950
Slit & mortise cutter	160	8	2	30	Insert = 1+1	WP50208
Slit & mortise cutter	180	12	2	30	Insert = 1+1	WP50312
Rustic profile / mat- ing slot & mortise	180	13	2	30	Radius = 4+4	WP51704



The following types of windows can be made with the WP Window cutter kit:

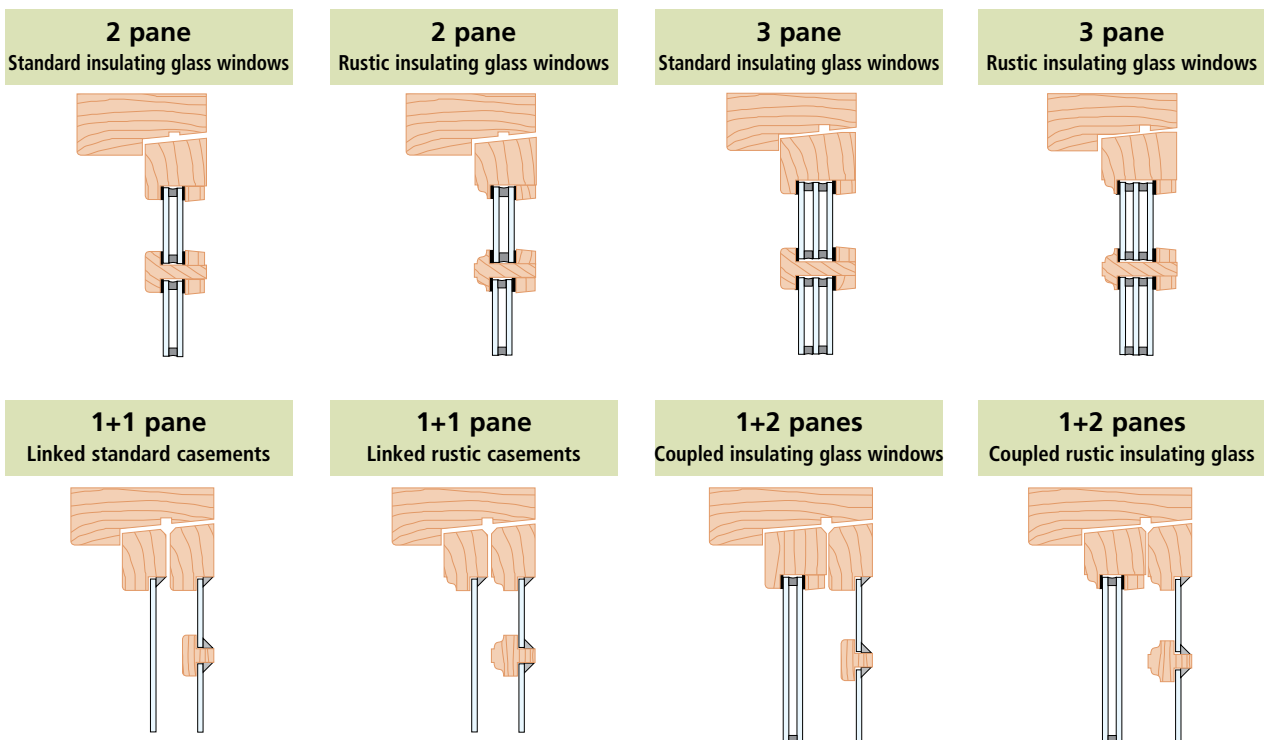

SUPPLEMENTARY KIT, MORTISE & TENON FOR CASEMENTS

Intended for cutting mortises and tenons in casements for outwards opening windows. Designed to suit all our window cutter kits.



SKU
WP50001

Cutters included in supplementary kit WP50001

Cutter	Diameter	Flute length	Degrees	Hole
Chamfer cutter	129,6	50	6	30
Chamfer cutter	136	30	6	30
Chamfer cutter	136	30		30
Chamfer cutter	136	50		30
Chamfer cutter	160	50		30

Mortise & Tenon for casement WP50001

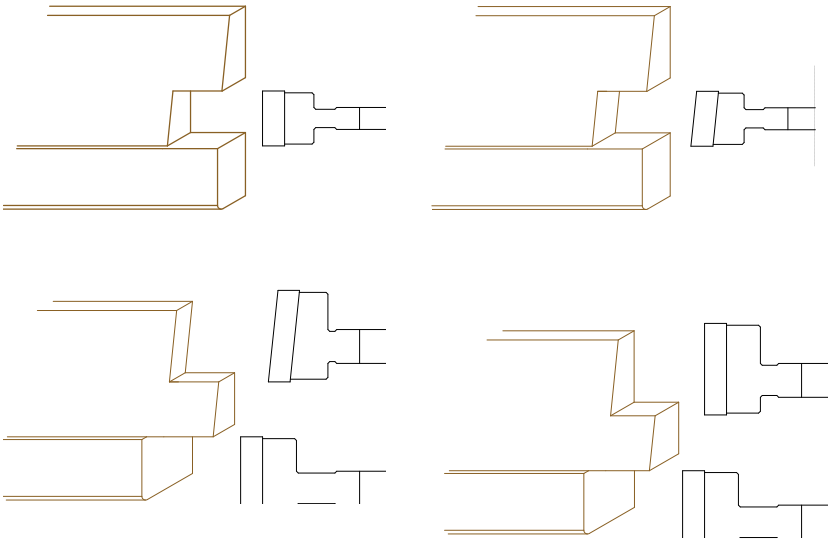

TB90 WINDOW CUTTER KIT

For making windows. This tool kit can be used to make conventional coupled casement 2 or 3 pane insulating glass windows with conventional casements and glazing bars. The requirement is that there must be access to a jointer/planer, a circular saw and a milling machine with a 30 mm spindle. This window cutter kit is the most flexible one commercially available, allowing you to configure your window production to meet customer requirements for profiling of the windows to be produced. To make production as efficient as possible with this kit, order an extra TB90-140S cutter, so you can make the tenons in one pass, as in the illustration on the next page.



Straight tongue & groove cutter with auxiliary blade

SKU	Dia.	Hole	Height	Blade	Insert
WP50208	160	30	8	2	2

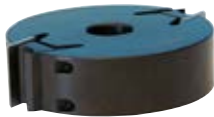

TB90-140S – Safety cutter with replaceable moulding knives + chip limiter

SKU	Material	Diameter	Height	Blade	Steel thickness
TB90-140	Steel	138	30	2 + chip limiter	4

Complete window cutter kit incl. cutters and knives. Order no. TB90-FönsterS

A chip limiter is included for all profiles



94753HSS
94753S



95027HSS
95027S



9000-20HSS
9000-20S



90127
90127S

The following types of windows can be made with the WP Window cutter kit:

<p>2 pane Standard insulating glass windows</p>	<p>2 pane Rustic insulating glass windows</p>	<p>3 pane Standard insulating glass windows</p>	<p>3 pane Rustic insulating glass windows</p>
<p>1+1 pane Linked standard casements</p>	<p>1+1 pane Linked rustic casements</p>	<p>1+2 panes Coupled insulating glass windows</p>	<p>1+2 panes Coupled rustic insulating glass</p>

SUPPLEMENTARY PROFILES FOR TB90 WINDOWS



Profile machining, window casement



Mating profile machining, window casement



Moulding knife: 94362HSS
Mating moulding knife: 94363HSS

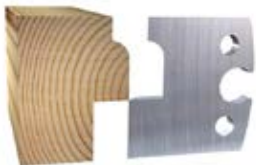

Moulding knife: 94364HSS
Mating moulding knife: 94365HSS



Moulding knife: 94366HSS
Mating moulding knife: 94367HSS



Moulding knife: 94368HSS
Mating moulding knife: 94369HSS



Moulding knife: 94370HSS
Mating moulding knife: 94371HSS



Moulding knife: 94372HSS
Mating moulding knife: 94373HSS

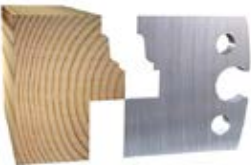

Moulding knife: 94374HSS
Mating moulding knife: 94375HSS

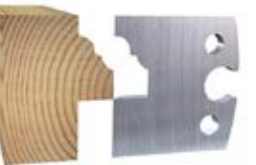

Moulding knife: 94376HSS
Mating moulding knife: 94377HSS



Moulding knife: 94378HSS
Mating moulding knife: 94379HSS

The window profiles above are designed to suit the TB90 window cutter kit. This means that the original tenon thickness is intended to be 8 mm, to suit the accompanying tongue & groove cutter. Please refer to moulding knives HSS 40 x 4 mm for detailed drawings of the above moulding/mating moulding knives. **Specify the profile number and finish off with an S to order chip limiters.**

SKU REGISTER – TB SYSTEM

SKU:	PAGE:	SKU:	PAGE:	SKU:	PAGE:	SKU:	PAGE:	SKU:	PAGE:	SKU:	PAGE:
9016	5	91308	54	94264	27, 44	94356	19-21, 47	94455	15	94553	22
9017	5	91309	54	94265	10, 19, 27, 44	94357	19, 47	94456	17	94554	22
9216	26	91310	54	94266	27, 44	94358	36, 47	94457	17	94555	22
9216	27	91311	54	94267	19-20, 44	94359	9, 47	94458	17-18	94556	22
64670	6	91312	54	94268	20, 45	94360	47	94459	17-18	94557	22
69027	16	91313	54	94269	18, 45	94361	47	94460	18	94558	22
90129	18, 19	91314	54	94270	45	94362	47	94461	18	94559	14
91001	20, 52	91315	54	94271	45	94364	47	94463	23-25	94560	14
91002	19, 20	91316	54	94272	18, 20, 45	94365	47	94464	23-24	94561	25
91003	27, 52	91317	54	94273	26, 45	94366	47	94465	22-25	94562	25
91004	30, 52	91318	54	94274	26, 45	94367	47	94466	23	94563	25
91010	52	91319	54	94275	31, 45	94368	47	94467	23, 37	94565	25
91011	52	91320	27, 54	94276	9, 45	94369	16-17, 47	94468	14	94566	25
91012	52	91321	19, 55	94277	9, 45	94370	47	94469	14	94567	25
91013	52	91323	55	94278	45	94371	47	94470	14	94568	25
91014	52	91324	55	94279	45	94372	47	94471	14	94571	7
91015	52	91325	55	94280	45	94373	48	94472	14	94572	7
91016	52	91326	55	94281	45	94374	48	94473	14	94573	7
91017	52	91327	24	94282	45	94375	48	94474	14	94574	29
91018	52	91328	25	94283	45	94376	48	94477	28	94575	14
91020	21, 53	91329	28	94284	45	94377	48	94478	28	94576	14
91021	31, 53	91330	29	94285	20, 45	94378	48	94479	22	94580	37
91022	27, 36	91331	29	94286	45	94379	48	94480	22	94581	37
91023	26, 53	91332	29	94287	45	94380	36, 48	94481	22	94582	37
91024	53	91333	29	94288	45	94381	33, 48	94482	22	94583	14
91025	20, 53	91343	16	94290	45	94382	33, 48	94483	23	94584	14
91028	28	91344	11	94291	45	94383	20, 48	94484	23	94585	31
91029	23	91716	34	94292	45	94384	9	94485	23	94586	31
91030	23	94200	8, 43	94293	9, 45	94389	7	94486	23	94587	31
91031	24	94201	8, 43	94294	9, 45	94390	7	94487	23	94588	31
91032	24	94202	8, 43	94295	30, 45	94396	17	94488	23	94589	37
91033	24	94203	8, 43	94296	45	94397	17	94489	23	94590	37
91034	24	94204	8, 43	94297	45	94398	17	94490	23	94591	37
91035	24	94205	8, 43	94298	45	94399	17	94491	23	94592	37
91036	24	94206	8, 43	94299	45	94400	16-17	94494	22	94593	37
91037	24	94207	8, 43	94300	45	94401	16-17	94495	23	94594	37
91038	24	94208	19-23, 30, 43	94301	33, 46	94402	16	94496	23	94595	37
91039	24	94209	8, 43	94302	33, 46	94403	16	94497	23	94596	37
91040	24	94210	8, 43	94303	33, 46	94404	17	94498	23	94597	37
91041	24	94211	9, 43	94304	5, 46	94405	17	94501	24	94598	37
91042	24	94212	9, 43	94305	5, 46	94406	17	94502	24	94600	38
91043	25	94213	5, 9, 43	94306	6, 46	94407	17	94503	24	94601	38
91044	25	94214	8-9, 12-13, 31, 39-40, 43	94308	6, 46	94408	37	94505	24	94602	38
91045	25	94215	18-19, 26-27, 39-40, 42-43	94310	6, 46	94409	37	94505	24	94603	38
91046	25	94216	26-27, 43	94312	6, 46	94410	16	94506	24	94604	38
91047	25	94217	43	94314	46	94411	15-18	94507	24	94605	38
91048	28	94218	10, 43	94315	46	94413	14	94508	24	94606	38
91049	28	94219	33, 39-40, 43	94316	9, 46	94414	14	94509	24	94607	38
91050	28	94220	43	94317	9, 46	94415	14	94510	24	94608	38
91051	29	94221	8, 43	94318	5	94416	14	94511	24	94609	38
91052	29	94222	43	94319	46	94417	14	94512	24	94610	38
91053	29	94223	43	94321	46	94418	14	94513	24	94611	38
91054	29	94224	43	94322	46	94419	16	94514	24	94612	38
91055	29	94225	43	94323	46	94420	16-17	94515	24	94613	38
91056	29	94226	43	94324	46	94421	16-17	94516	24	94616	15
91057	29	94227	43	94325	46	94422	17	94517	24	94617	15
91058	29	94229	44	94326	46	94423	17	94518	25	94618	15
91059	25	94232	44	94327	46	94424	17	94519	25	94619	15
91060	25	94234	44	94328	46	94425	17	94520	25	94620	15
91061	25	94236	44	94329	21	94426	17	94523	25	94621	15
91062	25	94238	44	94329	46	94427	17	94525	25	94622	31
91063	25	94240	44	94330	31	94429	17	94526	25	94622	31-32
91064	22	94241	44	94331	36, 46	94429	17	94527	25	94624	31
91072	17	94242	44	94332	36, 46	94430	15-16	94528	25	94625	32
91073	16	94243	44	94333	46	94431	16	94529	25	94626	32
91074	16	94244	8, 13, 31, 41, 44	94334	46	94432	16	94530	37	94627	32
91075	16	94245	44	94335	46	94433	15	94531	37	94628	38
91076	16	94246	44	94336	46	94434	15	94535	28	94629	38
91077	28	94247	44	94337	46	94437	16	94536	28	94630	38
91078	21	94248	19-22, 25, 30, 44	94338	46	94439	16	94537	28	94631	38
91079	21	94249	26, 49	94339	47	94440	16	94538	28	94632	38
91080	20	94250	44	94340	47	94441	16	94539	28	94633	38
91081	19	94251	19-20, 44	94341	47	94442	16	94540	28	94634	38
91082	26	94252	44	94342	47	94443	14-15	94541	28	94635	7
91083	21	94253	33, 44	94343	47	94444	14-15	94542	29	94636	7
91087	16	94254	25, 44	94345	9, 47	94445	15, 17	94543	29	94637	15
91088	16	94255	44	94347	47	94446	15	94544	29	94638	7, 15
91089	16	94256	44	94348	47	94447	15, 18	94545	15	94639	7
91301	26, 53	94257	8, 20, 44	94349	47	94448	14-15, 18	94546	15	94643	37
91302	53	94258	8, 20, 44	94350	47	94449	14	94547	35	94644	16
91303	53	94259	8, 18-20, 44	94351	47	94450	14	94548	35	94646	32
91304	53	94260	8, 44	94352	47	94451	14	94549	35	94647	15
91305	53	94261	39-40, 42, 44	94353	19, 21, 27, 47	94452	14	94550	35	94648	15
91306	53	94262	26, 44	94354	21, 47	94453	15, 17-18	94551	22	94650	28
91307	54	94263	26, 44	94355	27, 47	94454	15	94552	22	94651	28

SKU:	PAGE:	SKU:	PAGE:	SKU:	PAGE:	SKU:	PAGE:	SKU:	PAGE:
94654	13	94738	12	95048	50	95142	13	956073	37
94655	13	94739	12	95049	50	95143	13	ø81099HSS	58
94656	13	94740	12-13	95050	50	95146	10-11	ø81399HSS	58
94657	13-14	94741	12	95051	50	95147	30	ø841099HSS	58
94658	13-14	94742	12-13	95052	50	95148	21	ø841399HSS	58
94659	14	94743	12	95053	50	95149	36-37	ø84499HSS	58
94660	14	94744	12	95054	50	95151	37	ø84599HSS	58
94661	13-14	94745	12	95055	50	95152	37	ø84699HSS	58
94662	14	94746	12	95056	5, 50	95153	34	ø8499	58
94663	13	94747	12	95057	5, 50	95154	34	ø8499HM	58
94664	13	94748	12	95058	36, 50	95155	34	ø8499HSS	58
94665	13	94749	12	95059	36, 50	95156	35	ø8499S	58
94666	13	94750	12	95061	50	95158	21-22	ø85293	58
94667	13	94750	12	95062	50	95159	12	ø85499HM	58
94668	13	94751	12-13	95063	50	95160	12	ø85599HM	58
94670	6, 10-11	94756	13	95064	50	95161	12	ø85599HSS	58
94671	6, 10	94757	32	95065	50	95162	13	ø85699HSS	58
94672	11	94758	32	95066	50	95163	13	ø8599	58
94673	11	94759	32	95067	50	96001	51	ø8599HM	58
94674	11	94760	32	95068	50	96002	31, 51	ø8599HSS	58
94675	6, 11, 39-41	94768	37	95070	6, 50	96003	19, 51	ø8599S	58
94676	11	94781	42	95071	6, 50	96004	31, 51	ø8699	58
94677	11	94782	42	95072	9, 50	96005	27, 51	ø8699S	58
94678	11	94783	42	95073	26-29, 50	96006	26, 51	7000-000-9502	39-42
94679	11	94784	42	95074	27-28, 50	96007	26	7000-002-5202	56
94680	11	94786	42	95075	31, 50	96008	33, 51	7000-002-5212	56
94681	11	94787	39-40, 42	95076	36, 51	96009	19-20, 51	7000-002-5222	56
94682	11	94788	39-40	95077	51	96010	51	7000-002-5232	56
94683	11	94798	12	95078	5, 51	96011	51	7000-002-5237	56
94684	6	94800	39-41	95079	5, 51	96014	6, 51	7000-002-5242	56
94685	6	94801	39-40	95080	51	96015	6, 51	7500-001-0050	55
94686	6, 7	94814	40	95082	32, 51	96017	30, 51	7500-001-0051	55
94687	6, 39-41	94815	41	95083	32, 51	96018	19, 21, 51	8020-007-5202	57
94688	7	94832	39-41	95085	7	96019	19, 51	8020-007-5232	57
94689	11	94833	41	95086	7	96020	30, 51	8020-007-5252	57
94690	11	94834	41	95088	15-16	96021	30, 51	9000-16	8, 10-12, 16, 19, 35
94691	11	94835	41	95089	15-16	96022	20, 51	9000-20	16-17
94692	11	95001	48	95090	15	96025	16	900-16	13
94693	10	95002	32, 48	95091	16	96027	16	9016-2	5
94694	10	95003	32, 48	95092	16	96028	28	9016-3	5
94695	10	95004	8, 48	95093	28	96029	22	9017-2	5
94696	10	95005	8, 48	95094	22	96030	22	9017-3	5
94697	11	95006	30, 48	95095	23	96031	22	91002HSS	52
94698	10	95007	30, 48	95096	23	96032	22	9400-20	15
94699	10	95008	30, 48	95097	23	96033	23	9500-16	30
94700	10	95009	9, 48	95098	23	96034	23	9500-20	48
94701	21	95010	27, 42, 48	95099	23	96035	23	9600-20	51
94702	21	95011	10, 48	95100	23	96036	23	96007HSS	51
94703	36	95012	8-9, 48	95101	23	96037	23	KIL360-048	40
94704	6	95013	8-9, 18-19, 48	95102	23	96038	23	STOPPKIL-040	42
94705	10	95014	26, 48	95103	24	96039	23	TB90-008	40
94705	22	95015	9, 48	95104	24	96040	23	TB90-009	39
94706	10	95016	8, 27, 48	95105	25	96041	23	TB90-010	42
94707	33	95017	9, 19-20, 48	95106	25	96042	23	TB90-011	41
94708	33	95018	10, 49	95107	25	96043	24		
94709	33	95019	10, 26, 49	95108	37	96046	24		
94710	34	95020	10, 49	95109	29	96048	24		
94711	34	95021	5, 49	95110	29	96049	24		
94712	34	95022	5, 49	95111	29	96050	24		
94713	34	95023	5, 49	95112	29	96053	25		
94714	34	95024	5, 49	95113	35	96054	37		
94715	34	95025	18-19, 49	95114	25	96055	29		
94717	34	95026	49	95120	37	96056	29		
94718	34	95027	36, 49	95121	31	96057	29		
94719	34	95028	49	95122	15, 31	96058	29		
94720	27	95029	49	95123	37	96060	35		
94721	27	95030	5, 49	95124	37	96061	35		
94722	35	95031	5, 49	95125	7	96062	14		
94723	35	95032	26-28, 36, 38, 49	95126	7	96063	25		
94724	35	95033	18, 20, 49	95127	7	96065	28		
94725	35	95034	49	95128	7	96069	27		
94726	36	95035	49	95129	7	96070	35		
94727	36	95036	26, 49	95130	7	96071	21		
94728	36	95038	5, 49	95130	7	96072	21		
94729	36	95039	5, 49	95131	7	96075	16		
94730	36	95040	49	95132	15	96086	39-41		
94731	10	95041	49	95133	7	96087	39-40		
94732	11	95042	49	95134	7	96089	29		
94733	11	95043	49	95135	7	955144	11		
94734	11	95044	49	95138	28	955145	11		
94735	11	95045	33, 49	95139	22	955157	35		
94736	21	95046	33, 39	95140	13	956067	34		
94737	12	95047	31, 50	95141	13	956068	34		

SKU REGISTER – UNIVERSAL CUTTER HEADS

SKU:	PAGE:	SKU:	PAGE:
47093	65	TB90-140S	64
50110330	68	TB90-200S	64
50110530	68	TB90-84-20	62
7000-000-9502	66	TB90-84-30	62
7000-000-9506	66	TB90-92	62, 65
7000-000-9508	66	TB90-92 Steel	63
713, 104	67	TB90-92 Z4	63
713, 111	67	TB90-92S	64
713, 113	67	TB912-92	63
99-1318-2	66	TB912-92S	63
99-1318-3	66	TB98-100100	67
99-1318-82	66	TB98-100120	67
HM-9000	65	TB98-100180	67
HSS-100	67	TB98-120100	67
HSS-180	67	TB98-120180	67
KIL360-048	66	TBRS-12210030221	68
L141	65	TBRS-12213030221	68
L401	65	TBRS-1228030221	68
TB90-06	65	TBRS-13710050211	68
TB90-06S	65	TBRS-13718050411	68
TB90-10	65	TBRS-9010030211	68
TB90-10S	65	TBRS-9012030211	68
TB90-12	65	TBRS-906030211	68
TB90-120	64	TBRS-908030211	68
TB90-120Z4	64	WPTB90-06S	65
TB90-12S	65	WPTB90-98S	62
TB90-140	62		

SKU REGISTER – VERTICAL MILLING CUTTERS

SKU:	PAGE:	SKU:	PAGE:	SKU:	PAGE:
20200	73	94362HSS	87	WP50001	85
90127	86	94363HSS	87	WP50104	77
01,130,475G	71	94364HSS	87	WP50106	77
01,130,475M	71	94365HSS	87	WP50108	77
01,160,125,030G	71	94366HSS	87	WP50110	77
01,160,815,030G	71	94367HSS	87	WP50112	77
02,090,040	71	94368HSS	87	WP50206	77
02,125,030	71	94369HSS	87	WP50208	77
02,125,050	71	94370HSS	87	WP50208	84
02,125,050A4	71	94371HSS	87	WP50208	86
02,125,050S	71	94372HSS	87	WP50210	77
06,125,004	71	94373HSS	87	WP50212	77
06,125,006	71	94374HSS	87	WP50306	77
06,125,008	71	94375HSS	87	WP50308	77
06,125,010	71	94376HSS	87	WP50310	77
06,125,012	71	94377HSS	87	WP50312	77
06,180,008	71	94378HSS	87	WP50312	84
06,180,010	71	94379HSS	87	WP50401	77
06,180,012	71	94753HSS	86	WP50501	77
062,080,030	74	94753S	86	WP50601	77
080,080,030	74	95027HSS	86	WP50704	78
080,100,030	74	95027S	86	WP50704	84
080,120,030	74	A61-120-10	76	WP50705	78
10,150,050,030,S	72	A61-120-12	76	WP50710	78
10,160,060,030,S	72	A61-120-4	76	WP50715	78
11,160,020	72	A61-120-6	76	WP50775	78
11,180,040	74	A62-160	76	WP50801	80
12,120,040	72	A62-200	76	WP50802	80
13,120,050	72	A91-120-8	76	WP50903	82
14,180,040	74	FS4150011	78	WP51045	82
18,130,050,030A2	75	H08-120	80	WP51101	78
18,130,050,030S2	75	J134-116	79	WP51201	79
18,130,060,030A2	75	J166-160	81	WP51202	81
18,130,060,030S2	75	J176	80	WP51301	79
18,130,080,030S2	75	K002-100-30	71	WP51401	81
18,140,040,030A2	75	K002-100-50	71	WP51501	83
18,170,040,030S2	75	K002-125-30	71	WP51502	83
19,120,020,030A	76	K002-125-50	71	WP51606	84
19,120,020,130A	76	K019-140-50	72	WP51704	84
19,140,030,030A	76	Q27-120-R15	78	WP51845	84
19,140,030,130A	76	Q32-120-R10	78	WP51950	84
20,HK,19,SET58G	75	Q32-120-R5	78	WP52101	84
26-176-160	79	Q32-120-R7,5	78	WP52400	82
9000-20HSS	86	TB90-140	86	WP52500	83
9000-20S	86	V19-120-45	80		
90127S	86	WP50000	84		

ORDER FORM

SKU	PRODUCT/DESIGNATION	QTY.

THIS IS HOW YOU ORDER!

Buying from LOGOSOL is easy. Order from our e-store on www.logosol.com or by phone or email. You are welcome to call us and tell about your projects. We will help you find the right equipment for it.

Welcome to contact us!

LOGOSOL AB
 Fiskaregatan 2
 871 33 Härnösand
 SWEDEN
 Phone: +46 611-182 85 • Email: info@logosol.com
 Website: www.logosol.com

